

ラフテレーンクレーン
GR-1000N-1
フルオートジブ

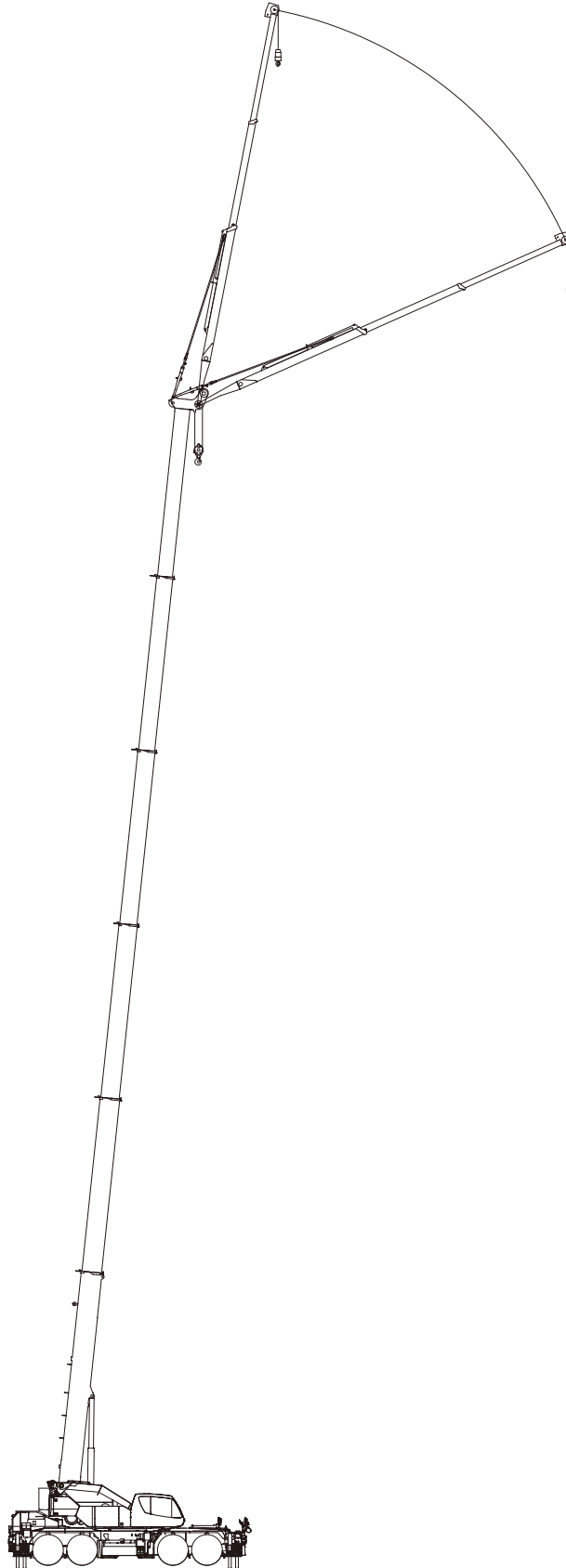

フルオートジブ定格総荷重表

■ 定格総荷重表注意事項

1. 定格総荷重は、水平堅土上においてクレーンを水平に設置した状態での値で、つり具と補巻フック質量(110kg)を含んだ値です。
太線より上はクレーンの強度により定められ、下はクレーンの安定度によって定められています。
2. 作業半径は、ブームおよびジブのたわみを含んだ実際の値に基づいていますので、必ず作業半径を基準にしてください。
3. 高速巻き下げは、フックのみを降下するときに使用してください。また、急激なレバー操作は避けてください。
4. ジブ使用時の補巻フックのワイヤロープ巻掛本数は1本です。主巻フックは35tフックを使用し、3本掛けとしてください。
5. 側方域でのつり上げ性能は、アウトリガ張出幅によって異なります。張出幅に応じた性能で作業をしてください。
また、前方・後方域でのつり上げ性能は「アウトリガ最大張出」の定格総荷重ですが、フロントアウトリガ張出幅とリアアウトリガ張出幅の組み合わせによってその前方・後方域の範囲(角度a、b)が異なります。

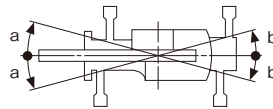

前方域									
角度 a°		フロントアウトリガ張出状態							
		最大張出		中間張出				最小張出	
		7.8m	7.6m	7.2m	6.4m	5.38m	4.18m	2.36m	
リアアウトリガ張出状態	最大張出	7.8m	90	75	65	55	40	10	5
	中間張出	7.6m	75	70	65	50	40	10	5
		7.2m	65	65	60	50	20	10	5
		6.4m	60	55	55	45	15	10	5
		5.38m	50	50	45	25	15	10	5
		4.18m	45	45	25	20	15	5	5
最小張出	2.36m	25	20	20	15	10	5	5	

後方域									
角度 b°		フロントアウトリガ張出状態							
		最大張出		中間張出				最小張出	
		7.8m	7.6m	7.2m	6.4m	5.38m	4.18m	2.36m	
リアアウトリガ張出状態	最大張出	7.8m	90	75	70	30	25	20	15
	中間張出	7.6m	75	70	35	25	25	20	15
		7.2m	30	30	25	25	20	20	15
		6.4m	20	20	20	20	15	15	10
		5.38m	15	15	10	10	10	10	10
		4.18m	5	5	5	5	5	5	5
最小張出	2.36m	5	5	5	5	5	-	-	

6. 各ブーム長さにおける各伸縮ブームの伸長状態(伸長割合%)は、下表のとおりです。

ブーム長さ	10.2m	38.2m	41.7m	45.2m	48.0m
伸縮ブーム 1 (%)	0	0	46	92	100
伸縮ブーム 2 (%)	0	92	92	92	100
伸縮ブーム 3 (%)	0	92	92	92	100
伸縮ブーム 4 (%)	0	92	92	92	100
伸縮ブーム 5 (%)	0	92	92	92	100

フルオートジブ

フルオートジブ定格総荷重表

7. スマートチャート性能選択時は前方・後方でスマートチャート1性能・スマートチャート2性能で作業が行えます。

スマートチャート性能は、フロントアウトリガ張出幅とリヤアウトリガ張出幅の組み合わせによって、スマートチャート1性能で作業が行える前方の範囲(角度c)、スマートチャート2性能で作業が行える前方の範囲(角度d)および後方の範囲(角度e)が異なります。また側方域でのつり上げ性能は、アウトリガ張出幅に応じた標準性能となります。

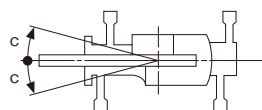



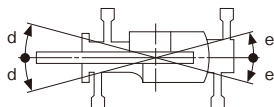











前方域 (スマートチャート1性能)									
角度 C°	フロントアウトリガ張出状態								
	最大張出	中間張出						最小張出	
	7.8m	7.6m	7.2m	6.4m	5.38m	4.18m	2.36m		
リヤアウトリガ張出状態	最大張出	7.8m	35	35	30	25	20	5	5
	中間張出	7.6m	35	35	30	25	20	5	5
		7.2m	35	30	30	25	15	5	5
		6.4m	30	30	25	20	10	5	5
		5.38m	25	25	25	20	10	5	5
		4.18m	20	20	20	15	10	5	5
最小張出	2.36m	15	15	15	15	5	5	5	



前方域 (スマートチャート2性能)									
角度 d°	フロントアウトリガ張出状態								
	最大張出	中間張出						最小張出	
	7.8m	7.6m	7.2m	6.4m	5.38m	4.18m	2.36m		
リヤアウトリガ張出状態	最大張出	7.8m	50	50	50	45	35	10	5
	中間張出	7.6m	50	50	50	45	35	10	5
		7.2m	50	50	50	40	15	10	5
		6.4m	50	50	45	40	15	10	5
		5.38m	50	45	45	20	15	10	5
		4.18m	45	45	25	20	15	5	5
最小張出	2.36m	20	20	20	15	10	5	5	

後方域 (スマートチャート2性能)									
角度 e°	フロントアウトリガ張出状態								
	最大張出	中間張出						最小張出	
	7.8m	7.6m	7.2m	6.4m	5.38m	4.18m	2.36m		
リヤアウトリガ張出状態	最大張出	7.8m	25	25	25	25	25	20	15
	中間張出	7.6m	25	25	25	25	20	20	15
		7.2m	25	25	25	20	20	20	15
		6.4m	20	20	15	15	15	15	10
		5.38m	10	10	10	10	10	10	10
		4.18m	5	5	5	5	5	5	5
最小張出	2.36m	5	5	5	5	5	-	-	





定格総荷重表中のシンボル、記号の説明

	フルオートジブ (FAJ) の定格総荷重を示します。		定格総荷重の単位を示します。
	フルオートジブ (FAJ) のジブ長さを示します。		ブーム長さを示します。
	カウンタウエイト (C/W) の質量を示します。		ジブのオフセット角度を示し、ブームの中心線とジブの中心線のなす角度を示します。
	アウトリガ張出幅を示します。		作業半径を示します。
	吊上げ可能な旋回範囲を示します。		ブーム伸縮状態 (伸縮割合 %) を示します。 IDはブーム伸縮状態に対応する番号を示します。
	スマートチャート1の場合、スマートチャート1性能で作業可能であることを示します。		無負荷状態で作動可能なブーム起伏角度範囲を示します。
	スマートチャート2の場合、スマートチャート2性能で作業可能であることを示します。		標準巻掛本数を示します。
			標準フックを示します。

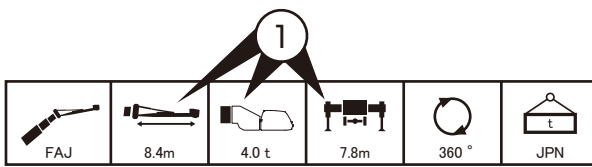
■ 定格総荷重表の見方

1. アウトリガ張出幅とカウンタウエイトの質量とジブ長さに応じた性能を選択します。
2. ブーム長さとIDとオフセット角度の欄を見ます。
3. 作業半径を見ます。
4. オフセット角度と作業半径が交差するところが定格総荷重です。



		10.2				38.2				41.7				45.2				48.0					
m		10.2	10.2	10.2	10.2	38.2	38.2	38.2	38.2	41.7	41.7	41.7	41.7	45.2	45.2	45.2	45.2	48.0	48.0	48.0	48.0	m	
°		5	25	45	60	5	25	45	60	5	25	45	60	5	25	45	60	5	25	45	60	°	
2.0	4.00																					2.0	
3.0	4.00																					3.0	
4.0	4.00		4.00																			4.0	
5.0	4.00	4.00																				5.0	
6.0	4.00	4.00	3.00																			6.0	
7.0	4.00	4.00	2.85		4.00					4.00												7.0	
8.0	4.00	4.00	2.70	1.60	4.00					4.00			4.00					4.00				8.0	
9.0	4.00	4.00	2.55	1.55	4.00					4.00			4.00					4.00				9.0	
10.0	4.00	3.90	2.45	1.50	4.00	4.00				4.00			4.00					4.00				10.0	
11.0	4.00	3.70	2.35		4.00	4.00				4.00			4.00	4.00				4.00				11.0	
12.0	4.00	3.50	2.30		4.00	4.00	2.65	1.55	4.00	4.00	2.65		4.00	3.95				4.00	3.70			12.0	
13.0	4.00	3.35			4.00	4.00	2.60	1.50		4.00	2.60	1.50	4.00	3.80	2.60			3.95	3.55			13.0	
14.0	4.00	3.20			4.00	3.85	2.55	1.50		4.00	3.75	2.55	1.50	4.00	3.65	2.55	1.50	3.85	3.45	2.60	1.50	14.0	
16.0					4.00	3.60	2.45	1.45		4.00	3.50	2.45	1.45	3.85	3.40	2.45	1.45	3.55	3.20	2.50	1.45	16.0	
18.0					3.75	3.35	2.35	1.40	3.65	3.25	2.35	1.40	3.55	3.20	2.40	1.40	3.30	3.05	2.40	1.40	1.40	18.0	
20.0					3.50	3.15	2.25	1.40	3.40	3.05	2.30	1.40	3.30	3.00	2.30	1.40	3.05	2.85	2.30	1.40	1.40	20.0	
22.0					3.25	2.95	2.20	1.35	3.20	2.90	2.20	1.35	3.10	2.80	2.25	1.35	2.70	2.60	2.25	1.35	1.35	22.0	
24.0					3.05	2.80	2.15		2.95	2.75	2.15	1.35	2.90	2.65	2.15	1.35	2.35	2.25	2.20	1.35	1.35	24.0	
26.0					2.85	2.65	2.10		2.80	2.60	2.10		2.70	2.55	2.10		2.00	1.95	1.95	1.30	1.30	26.0	
28.0					2.60	2.55	2.05		2.60	2.45	2.05		2.55	2.40	2.05		1.75	1.70	1.75			28.0	
30.0					2.35	2.40	2.00		2.35	2.35	2.00		2.10	2.30	2.00		1.50	1.50	1.50			30.0	
32.0					2.05	2.10			1.90	2.10	2.00		1.70	1.90	2.00		1.30	1.30	1.30			32.0	
34.0					1.70	1.85			1.55	1.70			1.30	1.50	1.60		1.10	1.10	1.15			34.0	
36.0					1.35	1.45			1.20	1.35			0.95	1.15			0.95	0.95	0.95			36.0	
38.0					1.05	1.15			0.90	1.00			0.65	0.80			0.65	0.80				38.0	
40.0					0.80				0.65	0.75			0.40	0.55				0.50				40.0	
42.0					0.55				0.40	0.50												42.0	
44.0																						44.0	
46.0																						46.0	
48.0																						48.0	
50.0																						50.0	
52.0																						52.0	
54.0																						54.0	
55.0																						55.0	
56.0																						56.0	
	1	0	0	0	0	0	0	0	0	46	46	46	46	92	92	92	92	100	100	100	100	1	
	2	0	0	0	0	92	92	92	92	92	92	92	92	92	92	92	92	100	100	100	100	2	
	3	0	0	0	0	92	92	92	92	92	92	92	92	92	92	92	100	100	100	100	3		
	4	0	0	0	0	92	92	92	92	92	92	92	92	92	92	92	100	100	100	100	4		
	5	0	0	0	0	92	92	92	92	92	92	92	92	92	92	92	100	100	100	100	5		
	ID	1	1	1	1	9	9	9	9	10	10	10	10	11	11	11	11	22	22	22	22	ID	
 [DEG]		28~84	35~84	54~84	68~84	18~84	35~84	54~84	68~84	30~84	38~84	54~84	67~84	41~84	45~84	55~84	69~84	48~84	48~84	55~84	68~84	[DEG]	
		1	1	1	1	1	1	1	1	1	1	1	1	1	1	1	1	1	1	1	1		
		5t	5t	5t	5t	5t	5t	5t	5t	5t	5t	5t	5t	5t	5t	5t	5t	5t	5t	5t	5t		

FAJ

フルオートジブ

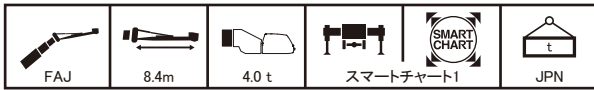

m		10.2	10.2	10.2	10.2	38.2	38.2	38.2	38.2	41.7	41.7	41.7	41.7	45.2	45.2	45.2	45.2	48.0	48.0	48.0	48.0	m	
°		5	25	45	60	5	25	45	60	5	25	45	60	5	25	45	60	5	25	45	60	°	
2.0	4.00																						2.0
3.0	4.00																						3.0
4.0	4.00	4.00																					4.0
5.0	4.00	4.00																					5.0
6.0	4.00	4.00	3.00																				6.0
7.0	4.00	4.00	2.85			4.00				4.00													7.0
8.0	4.00	4.00	2.70	1.60		4.00				4.00				4.00				4.00					8.0
9.0	4.00	4.00	2.55	1.55		4.00				4.00				4.00				4.00					9.0
10.0	4.00	3.90	2.45	1.50		4.00	4.00			4.00	4.00			4.00				4.00					10.0
11.0	4.00	3.70	2.35			4.00	4.00			4.00	4.00			4.00	4.00			4.00					11.0
12.0	4.00	3.50	2.30			4.00	4.00	2.65	1.55	4.00	4.00	2.65		4.00	3.95			4.00	3.70				12.0
13.0	4.00	3.35				4.00	4.00	2.60	1.50	4.00	3.90	2.60	1.50	4.00	3.80	2.60		3.95	3.55				13.0
14.0	4.00	3.20				4.00	3.85	2.55	1.50	4.00	3.75	2.55	1.50	4.00	3.65	2.55	1.50	3.85	3.45	2.60	1.50		14.0
16.0						4.00	3.60	2.45	1.45	3.95	3.50	2.45	1.45	3.85	3.40	2.45	1.45	3.55	3.20	2.50	1.45		16.0
18.0						3.75	3.35	2.35	1.40	3.65	3.25	2.35	1.40	3.55	3.20	2.40	1.40	3.30	3.05	2.40	1.40		18.0
20.0						3.50	3.15	2.25	1.40	3.40	3.05	2.30	1.40	3.30	3.00	2.30	1.40	3.05	2.85	2.30	1.40		20.0
22.0						3.25	2.95	2.20	1.35	3.20	2.90	2.20	1.35	3.10	2.80	2.25	1.35	2.70	2.60	2.25	1.35		22.0
24.0						3.05	2.80	2.15		2.95	2.75	2.15	1.35	2.90	2.65	2.15	1.35	2.35	2.25	2.20	1.35		24.0
26.0						2.85	2.65	2.10		2.80	2.60	2.10		2.70	2.55	2.10		2.00	1.95	1.95	1.30		26.0
28.0						2.60	2.55	2.05		2.60	2.45	2.05		2.55	2.40	2.05		1.75	1.70	1.75			28.0
30.0						2.35	2.40	2.00		2.50	2.35	2.00		2.40	2.30	2.00		1.50	1.50	1.50			30.0
32.0						2.05	2.10			2.25	2.25	2.00		2.30	2.20	2.00		1.30	1.30	1.30			32.0
34.0						1.85	1.90			2.05	2.05			2.20	2.10	1.95		1.10	1.10	1.15			34.0
36.0						1.60	1.65			1.85	1.85			1.95	2.00			0.95	0.95	0.95			36.0
38.0						1.40	1.45			1.65	1.65			1.60	1.75			0.80	0.80				38.0
40.0						1.25				1.45	1.50			1.25	1.40			0.65	0.65				40.0
42.0						1.10				1.25	1.30			0.95	1.05			0.50	0.55				42.0
44.0										0.95				0.70	0.80					0.40			44.0
46.0										0.70				0.45									46.0
48.0																							48.0
50.0																							50.0
52.0																							52.0
54.0																							54.0
55.0																							55.0
56.0																							56.0
1	0	0	0	0	0	0	0	0	0	46	46	46	46	92	92	92	92	100	100	100	100	100	1
2	0	0	0	0	0	92	92	92	92	92	92	92	92	92	92	92	92	100	100	100	100	100	2
3	0	0	0	0	0	92	92	92	92	92	92	92	92	92	92	92	92	100	100	100	100	100	3
4	0	0	0	0	0	92	92	92	92	92	92	92	92	92	92	92	92	100	100	100	100	100	4
5	0	0	0	0	0	92	92	92	92	92	92	92	92	92	92	92	92	100	100	100	100	100	5
ID	1	1	1	1	1	9	9	9	9	10	10	10	10	11	11	11	11	22	22	22	22	22	ID
[DEG]	28~84	35~84	54~84	68~84	84~84	35~84	54~84	68~84	84~84	15~84	33~84	54~84	67~84	28~84	37~84	55~84	69~84	42~84	42~84	55~84	68~84	[DEG]	
	1	1	1	1	1	1	1	1	1	1	1	1	1	1	1	1	1	1	1	1	1	1	
	5t	5t	5t	5t	5t	5t	5t	5t	5t	5t	5t	5t	5t	5t	5t	5t	5t	5t	5t	5t	5t	5t	

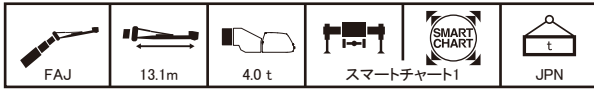

m		10.2	10.2	10.2	10.2	38.2	38.2	38.2	38.2	41.7	41.7	41.7	41.7	45.2	45.2	45.2	45.2	48.0	48.0	48.0	48.0	m	
°		5	25	45	60	5	25	45	60	5	25	45	60	5	25	45	60	5	25	45	60	°	
2.0	2.80																						2.0
3.0	2.80																						3.0
4.0	2.80																						4.0
5.0	2.80																						5.0
6.0	2.80																						6.0
7.0	2.80	2.60																					7.0
8.0	2.80	2.45				2.80				2.80				2.80									8.0
9.0	2.80	2.30				2.80				2.80				2.80									9.0
10.0	2.65	2.20	1.75			2.80				2.80				2.80				2.65					10.0
11.0	2.50	2.10	1.65			2.80				2.80				2.80				2.65					11.0
12.0	2.35	2.00	1.55	0.90		2.80				2.80				2.75				2.60					12.0
13.0	2.25	1.95	1.50	0.85	0.85	2.80	2.20			2.80	2.20			2.70				2.55					13.0
14.0	2.10	1.85	1.45	0.85	0.85	2.80	2.15			2.75	2.15			2.65	2.15			2.55					14.0
16.0	1.95	1.75	1.35			2.70	2.05	1.55		2.65	2.05	1.55		2.60	2.05			2.45	2.05				16.0
18.0	1.80	1.65				2.55	2.00	1.50	0.80	2.55	2.00	1.50	0.80	2.50	2.00	1.50	0.80	2.40	1.95	1.50			18.0
20.0		1.70				2.45	1.90	1.40	0.80	2.45	1.90	1.45	0.80	2.45	1.90	1.45	0.80	2.35	1.90	1.45	0.80		20.0
22.0						2.30	1.85	1.35	0.75	2.35	1.85	1.35	0.75	2.35	1.85	1.40	0.75	2.30	1.85	1.40	0.75		22.0
24.0						2.20	1.80	1.30	0.75	2.25	1.80	1.35	0.75	2.25	1.80	1.35	0.75	2.25	1.80	1.35	0.75		24.0
26.0						2.10	1.75	1.25	0.75	2.15	1.75	1.30	0.75	2.15	1.75	1.30	0.75	2.00	1.75	1.30	0.75		26.0
28.0						2.00	1.70	1.25		2.05	1.70	1.25	0.75	2.10	1.75	1.25	0.70	1.75	1.75	1.25	0.70		28.0
30.0						1.95	1.70	1.20		2.00	1.70	1.20		2.00	1.70	1.20	0.70	1.55	1.55	1.20	0.70		30.0
32.0						1.90	1.65	1.20		1.90	1.65	1.20		1.95	1.65	1.20		1.35	1.35	1.20			32.0
34.0						1.80	1.60	1.15		1.85	1.65	1.15		1.90	1.65	1.15		1.15	1.20	1.15			34.0
36.0						1.75	1.60			1.80	1.60	1.15		1.85	1.60	1.15		1.00	1.00	1.05			36.0
38.0						1.60	1.60			1.75	1.60			1.80	1.60	1.10		0.85	0.90	0.90			38.0
40.0						1.40	1.45			1.60	1.60			1.65	1.60	1.10		0.70	0.75	0.80			40.0
42.0						1.25	1.30			1.40	1.45			1.35	1.55			0.60	0.65				42.0
44.0						1.10				1.25	1.30			1.10	1.25			0.50	0.55				44.0
46.0						0.95				1.10	1.20			0.85	1.00			0.40	0.40				46.0
48.0																							

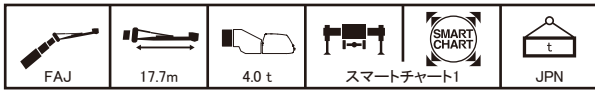

m		10.2	10.2	10.2	10.2	38.2	38.2	38.2	38.2	41.7	41.7	41.7	41.7	45.2	45.2	45.2	45.2	48.0	48.0	48.0	48.0	m	
°		5	25	45	60	5	25	45	60	5	25	45	60	5	25	45	60	5	25	45	60	°	
2.0																						2.0	
3.0	1.50																					3.0	
4.0	1.50																					4.0	
5.0	1.50																					5.0	
6.0	1.50																					6.0	
7.0	1.50																					7.0	
8.0	1.50					1.50																8.0	
9.0	1.50	1.25				1.50				1.50				1.45								9.0	
10.0	1.45	1.15				1.50				1.50				1.45				1.35				10.0	
11.0	1.35	1.10				1.50				1.45				1.40				1.35				11.0	
12.0	1.25	1.05				1.45				1.45				1.40				1.35				12.0	
13.0	1.20	1.00				1.45				1.40				1.35				1.30				13.0	
14.0	1.15	0.95	0.85			1.40				1.40				1.35				1.30				14.0	
16.0	1.00	0.90	0.80	0.55		1.35	1.00			1.30	1.00			1.30	1.00			1.25				16.0	
18.0	0.95	0.85	0.75	0.50		1.30	0.95			1.25	0.95			1.25	0.95			1.20	0.95			18.0	
20.0	0.85	0.80	0.75	0.50		1.20	0.90	0.75		1.20	0.90	0.75		1.20	0.90			1.15	0.90			20.0	
22.0	0.80	0.75	0.70			1.15	0.90	0.75	0.50	1.15	0.90	0.75	0.50	1.15	0.90	0.75		1.15	0.90	0.75		22.0	
24.0	0.75	0.75				1.10	0.85	0.70	0.45	1.10	0.85	0.70	0.45	1.10	0.85	0.70	0.45	1.10	0.85	0.70	0.45	24.0	
26.0						1.05	0.85	0.70	0.45	1.05	0.85	0.70	0.45	1.05	0.85	0.70	0.45	1.05	0.85	0.70	0.45	26.0	
28.0						1.00	0.80	0.70	0.45	1.00	0.80	0.70	0.45	1.00	0.80	0.70	0.45	1.00	0.80	0.70	0.45	28.0	
30.0						0.95	0.80	0.70	0.45	0.95	0.80	0.70	0.45	0.95	0.80	0.70	0.45	1.00	0.80	0.70	0.45	30.0	
32.0						0.90	0.75	0.70		0.95	0.75	0.70	0.40	0.95	0.75	0.70	0.40	0.95	0.75	0.70	0.40	32.0	
34.0						0.85	0.75	0.70		0.90	0.75	0.70		0.90	0.75	0.70	0.40	0.90	0.75	0.70	0.40	34.0	
36.0						0.85	0.75	0.70		0.85	0.75	0.70		0.90	0.75	0.70		0.90	0.75	0.65	0.40	36.0	
38.0						0.80	0.70	0.70		0.85	0.70	0.70		0.85	0.70	0.65		0.85	0.70	0.65		38.0	
40.0						0.80	0.70	0.70		0.80	0.70	0.70		0.80	0.70	0.65		0.75	0.70	0.65		40.0	
42.0						0.75	0.70			0.80	0.70	0.70		0.80	0.70	0.65		0.65	0.70	0.65		42.0	
44.0						0.75	0.70			0.75	0.70			0.80	0.70	0.65		0.55	0.60	0.65		44.0	
46.0						0.75	0.70			0.75	0.70			0.75	0.70			0.45	0.50	0.55		46.0	
48.0						0.70	0.70			0.75	0.70			0.75	0.70				0.40				48.0
50.0						0.70				0.70	0.70			0.70	0.70								50.0
52.0						0.70				0.70				0.50	0.70								52.0
54.0										0.60					0.45								54.0
55.0										0.50													55.0
56.0										0.45													56.0
1	0	0	0	0	0	0	0	0	0	46	46	46	46	92	92	92	92	100	100	100	100	1	
2	0	0	0	0	0	92	92	92	92	92	92	92	92	92	92	92	92	100	100	100	100	2	
3	0	0	0	0	0	92	92	92	92	92	92	92	92	92	92	92	92	100	100	100	100	3	
4	0	0	0	0	0	92	92	92	92	92	92	92	92	92	92	92	92	100	100	100	100	4	
5	0	0	0	0	0	92	92	92	92	92	92	92	92	92	92	92	92	100	100	100	100	5	
ID	1	1	1	1	1	9	9	9	9	10	10	10	10	11	11	11	11	22	22	22	22	ID	
[DEG]	19~84	31~84	51~84	65~84	17~84	37~84	54~84	71~84	0~84	40~84	55~84	70~84	37~84	39~84	57~84	69~84	49~84	52~84	57~84	68~84	[DEG]		
	1	1	1	1	1	1	1	1	1	1	1	1	1	1	1	1	1	1	1	1	1		
	5t	5t	5t	5t	5t	5t	5t	5t	5t	5t	5t	5t	5t	5t	5t	5t	5t	5t	5t	5t	5t		



m		10.2	10.2	10.2	10.2	38.2	38.2	38.2	38.2	41.7	41.7	41.7	41.7	45.2	45.2	45.2	45.2	48.0	48.0	48.0	48.0	m
°		5	25	45	60	5	25	45	60	5	25	45	60	5	25	45	60	5	25	45	60	°
2.0	4.00																					2.0
3.0	4.00																					3.0
4.0	4.00	4.00																				4.0
5.0	4.00	4.00																				5.0
6.0	4.00	4.00	3.00																			6.0
7.0	4.00	4.00	2.85			4.00				4.00												7.0
8.0	4.00	4.00	2.70	1.60		4.00				4.00				4.00				4.00				8.0
9.0	4.00	4.00	2.55	1.55	4.00					4.00				4.00				4.00				9.0
10.0	4.00	3.90	2.45	1.50	4.00	4.00				4.00	4.00			4.00				4.00				10.0
11.0	4.00	3.70	2.35		4.00	4.00				4.00	4.00			4.00	4.00			4.00				11.0
12.0	4.00	3.50	2.30		4.00	4.00	2.65	1.55	4.00	4.00	2.65			4.00	3.95			4.00	3.70			12.0
13.0	4.00	3.35			4.00	4.00	2.60	1.50	4.00	3.90	2.60	1.50	4.00	3.80	2.60			3.95	3.55			13.0
14.0	4.00	3.20			4.00	3.85	2.55	1.50	4.00	3.75	2.55	1.50	4.00	3.65	2.55	1.50		3.85	3.45	2.60	1.50	14.0
16.0					4.00	3.60	2.45	1.45	3.95	3.50	2.45	1.45	3.85	3.40	2.45	1.45	3.55	3.20	2.50	1.45	16.0	
18.0					4.00	3.75	2.35	1.40	3.65	3.25	2.35	1.40	3.55	3.20	2.40	1.40	3.30	3.05	2.40	1.40	18.0	
20.0					4.00	3.50	2.25	1.40	3.40	3.05	2.30	1.40	3.30	3.00	2.30	1.40	3.05	2.85	2.30	1.40	20.0	
22.0					4.00	3.25	2.95	2.20	1.35	3.20	2.90	2.20	1.35	3.10	2.80	2.25	1.35	2.70	2.60	2.25	1.35	22.0
24.0					4.00	3.05	2.80	2.15		2.95	2.75	2.15	1.35	2.90	2.65	2.15	1.35	2.35	2.25	2.20	1.35	24.0
26.0					4.00	2.85	2.65	2.10		2.80	2.60	2.10		2.70	2.55	2.10		2.00	1.95	1.95	1.30	26.0
28.0					4.00	2.60	2.55	2.05		2.60	2.45	2.05		2.55	2.40	2.05		1.75	1.70	1.75		28.0
30.0					4.00	2.35	2.40	2.00		2.50	2.35	2.00		2.40	2.30	2.00		1.50	1.50	1.50		30.0
32.0					4.00	2.05	2.10			2.25	2.25	2.00		2.30	2.20	2.00		1.30	1.30	1.30		32.0
34.0					4.00	1.85	1.90			2.05	2.05			1.85	2.05	1.95		1.10	1.10	1.15		34.0
36.0					4.00	1.60	1.65			1.70	1.85			1.50	1.65			0.95	0.95	0.95		36.0
38.0					4.00	1.40	1.45			1.40	1.50			1.15	1.30			0.80	0.80			38.0
40.0					4.00	1.25				1.10	1.20			0.85	1.00			0.65	0.65			40.0
42.0					4.00	1.00				0.85	0.90			0.60	0.70			0.50	0.55			42.0
44.0					4.00					0.60												44.0
46.0					4.00					0.40												46.0
48.0					4.00																	48.0
50.0					4.00																	50.0
52.0					4.00				</													

フルオートジブ

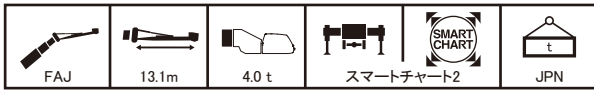

m		10.2	10.2	10.2	10.2	38.2	38.2	38.2	38.2	41.7	41.7	41.7	41.7	45.2	45.2	45.2	45.2	48.0	48.0	48.0	48.0	m	
°		5	25	45	60	5	25	45	60	5	25	45	60	5	25	45	60	5	25	45	60	°	
2.0	2.80																						2.0
3.0	2.80																						3.0
4.0	2.80																						4.0
5.0	2.80																						5.0
6.0	2.80																						6.0
7.0	2.80	2.60																					7.0
8.0	2.80	2.45				2.80				2.80													8.0
9.0	2.80	2.30				2.80				2.80				2.80									9.0
10.0	2.65	2.20				2.80				2.80				2.80					2.65				10.0
11.0	2.50	2.10	1.65			2.80				2.80				2.80					2.65				11.0
12.0	2.35	2.00	1.55	0.90		2.80				2.80				2.75					2.60				12.0
13.0	2.25	1.95	1.50	0.85		2.80	2.20			2.80	2.20			2.70					2.55				13.0
14.0	2.10	1.85	1.45	0.85		2.80	2.15			2.75	2.15			2.65	2.15				2.55				14.0
16.0	1.95	1.75	1.35			2.70	2.05	1.55		2.65	2.05	1.55		2.60	2.05				2.45	2.05			16.0
18.0	1.80	1.65				2.55	2.00	1.50	0.80	2.55	2.00	1.50	0.80	2.50	2.00	1.50	0.80		2.40	1.95	1.50		18.0
20.0	1.70					2.45	1.90	1.40	0.80	2.45	1.90	1.45	0.80	2.45	1.90	1.45	0.80		2.35	1.90	1.45	0.80	20.0
22.0						2.30	1.85	1.35	0.75	2.35	1.85	1.35	0.75	2.35	1.85	1.40	0.75		2.30	1.85	1.40	0.75	22.0
24.0						2.20	1.80	1.30	0.75	2.25	1.80	1.35	0.75	2.25	1.80	1.35	0.75		2.25	1.80	1.35	0.75	24.0
26.0						2.10	1.75	1.25	0.75	2.15	1.75	1.30	0.75	2.15	1.75	1.30	0.75		2.00	1.75	1.30	0.75	26.0
28.0						2.00	1.70	1.25		2.05	1.70	1.25	0.75	2.10	1.75	1.25	0.70		1.75	1.75	1.25	0.70	28.0
30.0						1.95	1.70	1.20		2.00	1.70	1.20		2.00	1.70	1.20	0.70		1.55	1.55	1.20	0.70	30.0
32.0						1.90	1.65	1.20		1.90	1.65	1.20		1.95	1.65	1.20			1.35	1.35	1.20		32.0
34.0						1.80	1.60	1.15		1.85	1.65	1.15		1.90	1.65	1.15			1.15	1.20	1.15		34.0
36.0						1.75	1.60			1.80	1.60	1.15		1.85	1.60	1.15			1.00	1.00	1.05		36.0
38.0						1.60	1.60			1.75	1.60			1.50	1.60	1.10			0.85	0.90	0.90		38.0
40.0						1.40	1.45			1.45	1.60			1.20	1.45	1.10			0.70	0.75	0.80		40.0
42.0						1.25	1.30			1.20	1.35			0.95	1.15				0.60	0.65			42.0
44.0						1.10				0.95	1.10			0.70	0.90				0.50	0.55			44.0
46.0						0.90				0.75	0.85			0.50	0.65				0.40	0.40			46.0
48.0						0.70				0.55													48.0
50.0																							50.0
52.0																							52.0
54.0																							54.0
55.0																							55.0
56.0																							56.0
1	0	0	0	0	0	0	0	0	0	46	46	46	46	92	92	92	92	100	100	100	100	100	1
2	0	0	0	0	0	92	92	92	92	92	92	92	92	92	92	92	92	100	100	100	100	100	2
3	0	0	0	0	0	92	92	92	92	92	92	92	92	92	92	92	92	100	100	100	100	100	3
4	0	0	0	0	0	92	92	92	92	92	92	92	92	92	92	92	92	100	100	100	100	100	4
5	0	0	0	0	0	92	92	92	92	92	92	92	92	92	92	92	92	100	100	100	100	100	5
ID	1	1	1	1	1	9	9	9	9	10	10	10	10	11	11	11	11	22	22	22	22	22	ID
[DEG]	0~84	40~84	57~84	71~84	0~84	38~84	56~84	69~84	26~84	37~84	57~84	68~84	39~84	43~84	54~84	68~84	43~84	47~84	57~84	70~84	[DEG]		
	1	1	1	1	1	1	1	1	1	1	1	1	1	1	1	1	1	1	1	1	1	1	
	5t	5t	5t	5t	5t	5t	5t	5t	5t	5t	5t	5t	5t	5t	5t	5t	5t	5t	5t	5t	5t	5t	

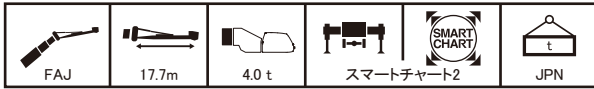

m		10.2	10.2	10.2	10.2	38.2	38.2	38.2	38.2	41.7	41.7	41.7	41.7	45.2	45.2	45.2	45.2	48.0	48.0	48.0	48.0	m	
°		5	25	45	60	5	25	45	60	5	25	45	60	5	25	45	60	5	25	45	60	°	
2.0																							2.0
3.0	1.50																						3.0
4.0	1.50																						4.0
5.0	1.50																						5.0
6.0	1.50																						6.0
7.0	1.50																						7.0
8.0	1.50					1.50																	8.0
9.0	1.50	1.25				1.50				1.50				1.45									9.0
10.0	1.45	1.15				1.50				1.50				1.45					1.35				10.0
11.0	1.35	1.10				1.50				1.45				1.40					1.35				11.0
12.0	1.25	1.05				1.45				1.45				1.40					1.35				12.0
13.0	1.20	1.00				1.45				1.40				1.35					1.30				13.0
14.0	1.15	0.95	0.85			1.40				1.40				1.35					1.30				14.0
16.0	1.00	0.90	0.80	0.55		1.35	1.00			1.30	1.00			1.30	1.00				1.25				16.0
18.0	0.95	0.85	0.75	0.50		1.30	0.95			1.25	0.95			1.25	0.95				1.20	0.95			18.0
20.0	0.85	0.80	0.75	0.50		1.20	0.90	0.75		1.20	0.90	0.75		1.20	0.90				1.15	0.90			20.0
22.0	0.80	0.75	0.70			1.15	0.90	0.75	0.50	1.15	0.90	0.75	0.50	1.15	0.90	0.75			1.15	0.90	0.75		22.0
24.0	0.75	0.75				1.10	0.85	0.70	0.45	1.10	0.85	0.70	0.45	1.10	0.85	0.70	0.45		1.10	0.85	0.70	0.45	24.0
26.0						1.05	0.85	0.70	0.45	1.05	0.85	0.70	0.45	1.05	0.85	0.70	0.45		1.05	0.85	0.70	0.45	26.0
28.0						1.00	0.80	0.70	0.45	1.00	0.80	0.70	0.45	1.05	0.80	0.70	0.45		1.00	0.80	0.70	0.45	28.0
30.0						0.95	0.80	0.70	0.45	0.95	0.80	0.70	0.45	1.00	0.80	0.70	0.45		1.00	0.80	0.70	0.45	30.0
32.0						0.90	0.75	0.70		0.95	0.75	0.70	0.40	0.95	0.75	0.70	0.40		0.95	0.75	0.70	0.40	32.0
34.0						0.85	0.75	0.70		0.90	0.75	0.70		0.90	0.75	0.70	0.40		0.90	0.75	0.70	0.40	34.0
36.0						0.85	0.75	0.70		0.85	0.75	0.70		0.90	0.75	0.70			0.90	0.75	0.65	0.40	36.0
38.0						0.80	0.70	0.70		0.85	0.70	0.70		0.85	0.70	0.65			0.85	0.70	0.65		38.0
40.0						0.80	0.70	0.70		0.80	0.70	0.70		0.80	0.70	0.65			0.75	0.70	0.65		40.0
42.0						0.75	0.70	0.70		0.80	0.70	0.70		0.80	0.70	0.65			0.65	0.70	0.65		42.0
44.0						0.75	0.70			0.75	0.70			0.80	0.70	0.65			0.65	0.60	0.65		44.0
46.0						0.75	0.70			0.75	0.70			0.75	0.70				0.45	0.50	0.55		46.0
48.0						0.70	0.70			0.75	0.70			0.60									

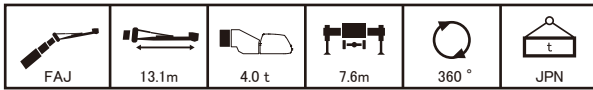

m		10.2	10.2	10.2	10.2	38.2	38.2	38.2	38.2	41.7	41.7	41.7	41.7	45.2	45.2	45.2	45.2	48.0	48.0	48.0	48.0	m				
°		5	25	45	60	5	25	45	60	5	25	45	60	5	25	45	60	5	25	45	60	°				
2.0	2.80																					2.0				
3.0	2.80																					3.0				
4.0	2.80																					4.0				
5.0	2.80																					5.0				
6.0	2.80																					6.0				
7.0	2.80	2.60																				7.0				
8.0	2.80	2.45				2.80				2.80												8.0				
9.0	2.80	2.30				2.80				2.80				2.80								9.0				
10.0	2.65	2.20				2.80				2.80				2.80					2.65			10.0				
11.0	2.50	2.10	1.75			2.80				2.80				2.80					2.65			11.0				
12.0	2.35	2.00	1.55	0.90		2.80				2.80				2.75					2.60			12.0				
13.0	2.25	1.95	1.50	0.85	2.80	2.20				2.80	2.20			2.70					2.55			13.0				
14.0	2.10	1.85	1.45	0.85	2.80	2.15				2.75	2.15			2.65	2.15				2.55			14.0				
16.0	1.95	1.75	1.35		2.70	2.05	1.55			2.65	2.05	1.55		2.60	2.05				2.45	2.05		16.0				
18.0	1.80	1.65			2.55	2.00	1.50	0.80		2.55	2.00	1.50	0.80	2.50	2.00	1.50	0.80		2.40	1.95	1.50	18.0				
20.0	1.70				2.45	1.90	1.40	0.80	2.45	1.90	1.45	0.80	2.45	1.90	1.45	0.80		2.35	1.90	1.45	0.80	20.0				
22.0					2.30	1.85	1.35	0.75	2.35	1.85	1.35	0.75	2.35	1.85	1.40	0.75		2.30	1.85	1.40	0.75	22.0				
24.0					2.20	1.80	1.30	0.75	2.25	1.80	1.35	0.75	2.25	1.80	1.35	0.75		2.25	1.80	1.35	0.75	24.0				
26.0					2.10	1.75	1.25	0.75	2.15	1.75	1.30	0.75	2.15	1.75	1.30	0.75		2.00	1.75	1.30	0.75	26.0				
28.0					2.00	1.70	1.25		2.05	1.70	1.25	0.75	2.10	1.75	1.25	0.70		1.75	1.75	1.25	0.70	28.0				
30.0					1.95	1.70	1.20		2.00	1.70	1.20		2.00	1.70	1.20	0.70		1.55	1.55	1.20	0.70	30.0				
32.0					1.90	1.65	1.20		1.90	1.65	1.20		1.90	1.65	1.20			1.35	1.35	1.20		32.0				
34.0					1.80	1.60	1.15		1.80	1.65	1.15		1.55	1.65	1.15			1.15	1.20	1.15		34.0				
36.0					1.60	1.60			1.45	1.60	1.15		1.20	1.50	1.15			1.00	1.00	1.05		36.0				
38.0					1.30	1.50			1.15	1.35			0.90	1.15	1.10			0.85	0.90	0.90		38.0				
40.0					1.05	1.20			0.90	1.10			0.65	0.90	1.00			0.60	0.75	0.80		40.0				
42.0					0.80	0.95			0.65	0.80				0.60				0.40	0.60			42.0				
44.0					0.60					0.60													44.0			
46.0																							46.0			
48.0																							48.0			
50.0																							50.0			
52.0																							52.0			
54.0																							54.0			
55.0																							55.0			
56.0																							56.0			
%		1	0	0	0	0	0	0	0	46	46	46	46	92	92	92	92	100	100	100	100	100	1			
ID		1	1	1	1	1	1	1	1	9	9	9	9	10	10	10	10	11	11	11	11	22	22	22	22	ID
[DEG]		0~84	84~84	57~84	71~84	28~84	38~84	56~84	69~84	39~84	41~84	57~84	68~84	48~84	49~84	54~84	68~84	48~84	52~84	57~84	70~84	[DEG]				
t		5t	5t	5t	5t	5t	5t	5t	5t	5t	5t	5t	5t	5t	5t	5t	5t	5t	5t	5t	5t					

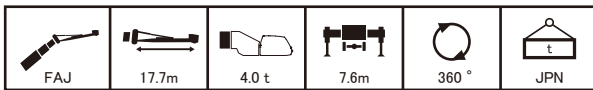

m		10.2	10.2	10.2	10.2	38.2	38.2	38.2	38.2	41.7	41.7	41.7	41.7	45.2	45.2	45.2	45.2	48.0	48.0	48.0	48.0	m				
°		5	25	45	60	5	25	45	60	5	25	45	60	5	25	45	60	5	25	45	60	°				
2.0	1.50																					2.0				
3.0	1.50																					3.0				
4.0	1.50																					4.0				
5.0	1.50																					5.0				
6.0	1.50																					6.0				
7.0	1.50																					7.0				
8.0	1.50					1.50				1.50				1.45								8.0				
9.0	1.50	1.25				1.50				1.50				1.45					1.35			9.0				
10.0	1.45	1.15				1.50				1.50				1.45					1.35			10.0				
11.0	1.35	1.10				1.50				1.45				1.40					1.35			11.0				
12.0	1.25	1.05				1.45				1.45				1.40					1.35			12.0				
13.0	1.20	1.00				1.45				1.40				1.35					1.30			13.0				
14.0	1.15	0.95	0.85			1.40				1.40				1.35					1.30			14.0				
16.0	1.00	0.90	0.80	0.55		1.35	1.00			1.30	1.00			1.30	1.00				1.25			16.0				
18.0	0.95	0.85	0.75	0.50	1.30	0.95				1.25	0.95			1.25	0.95				1.20	0.95		18.0				
20.0	0.85	0.80	0.75	0.50	1.20	0.90	0.75			1.20	0.90	0.75		1.20	0.90				1.15	0.90		20.0				
22.0	0.80	0.75	0.70		1.15	0.90	0.75	0.50		1.15	0.90	0.75	0.50	1.15	0.90	0.75			1.15	0.90	0.75	22.0				
24.0	0.75	0.75			1.10	0.85	0.70	0.45	1.10	0.85	0.70	0.45	1.10	0.85	0.70	0.45			1.10	0.85	0.70	0.45	24.0			
26.0					1.05	0.85	0.70	0.45	1.05	0.85	0.70	0.45	1.05	0.85	0.70	0.45			1.05	0.85	0.70	0.45	26.0			
28.0					1.00	0.80	0.70	0.45	1.00	0.80	0.70	0.45	1.00	0.80	0.70	0.45			1.00	0.80	0.70	0.45	28.0			
30.0					0.95	0.80	0.70	0.45	0.95	0.80	0.70	0.45	1.00	0.80	0.70	0.45			1.00	0.80	0.70	0.45	30.0			
32.0					0.90	0.75	0.70		0.95	0.75	0.70		0.90	0.75	0.70	0.40			0.95	0.75	0.70	0.40	32.0			
34.0					0.85	0.75	0.70		0.90	0.75	0.70		0.90	0.75	0.70	0.40			0.90	0.75	0.70	0.40	34.0			
36.0					0.85	0.75	0.70		0.85	0.75	0.70		0.90	0.75	0.70				0.90	0.75	0.65	0.40	36.0			
38.0					0.80	0.70	0.70		0.85	0.70	0.70		0.85	0.70	0.65				0.85	0.70	0.65		38.0			
40.0					0.80	0.70	0.70		0.80	0.70	0.70		0.80	0.70	0.65				0.75	0.70	0.65		40.0			
42.0					0.75	0.70			0.80	0.70	0.70		0.75	0.70	0.65				0.65	0.70	0.65		42.0			
44.0					0.75	0.70			0.75	0.70			0.50	0.70	0.65				0.45	0.60	0.65		44.0			
46.0					0.70	0.70			0.55	0.70			0.50	0.70	0.65				0.45	0.50	0.55		46.0			
48.0					0.55	0.65			0.40	0.55				0.55					0.50	0.55			48.0			
50.0					0.40																		50.0			
52.0																							52.0			
54.0																							54.0			
55.0																							55.0			
56.0																							56.0			
%		1	0	0	0	0	0	0	0	46	46	46	46	92	92	92	92	100	100	100	100	100	1			
ID		1	1	1	1	1	1	1	1	9	9	9	9	10	10	10	10	11	11	11	11	22	22	22	22	ID
[DEG]		19~84	31~84																							

フルオートジブ

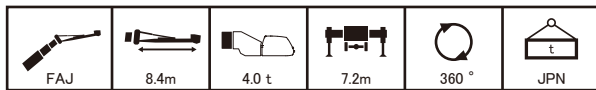





m	10.2				38.2				41.7				45.2				48.0				m	
	5	25	45	60	5	25	45	60	5	25	45	60	5	25	45	60	5	25	45	60		
2.0	4.00																				2.0	
3.0	4.00																				3.0	
4.0	4.00	4.00																			4.0	
5.0	4.00	4.00																			5.0	
6.0	4.00	4.00	3.00																		6.0	
7.0	4.00	4.00	2.85		4.00				4.00												7.0	
8.0	4.00	4.00	2.70	1.60	4.00				4.00					4.00				4.00			8.0	
9.0	4.00	4.00	2.55	1.55	4.00				4.00					4.00				4.00			9.0	
10.0	4.00	3.90	2.45	1.50	4.00	4.00			4.00	4.00				4.00				4.00			10.0	
11.0	4.00	3.70	2.35		4.00	4.00			4.00	4.00				4.00	4.00			4.00			11.0	
12.0	4.00	3.50	2.30		4.00	4.00	2.65	1.55	4.00	4.00	2.65			4.00	3.95			4.00	3.70		12.0	
13.0	4.00	3.35			4.00	4.00	2.60	1.50	4.00	3.90	2.60	1.50		4.00	3.80	2.60		3.95	3.55		13.0	
14.0	4.00	3.20			4.00	3.85	2.55	1.50	4.00	3.75	2.55	1.50		4.00	3.65	2.55	1.50	3.85	3.45	2.60	1.50	14.0
16.0					4.00	3.60	2.45	1.45	3.95	3.50	2.45	1.45		3.85	3.40	2.45	1.45	3.55	3.20	2.50	1.45	16.0
18.0					3.75	3.35	2.35	1.40	3.65	3.25	2.35	1.40		3.55	3.20	2.40	1.40	3.30	3.05	2.40	1.40	18.0
20.0					3.50	3.15	2.25	1.40	3.40	3.05	2.30	1.40		3.30	3.00	2.30	1.40	3.05	2.85	2.30	1.40	20.0
22.0					3.25	2.95	2.20	1.35	3.20	2.90	2.20	1.35		3.10	2.80	2.25	1.35	2.70	2.60	2.25	1.35	22.0
24.0					3.05	2.80	2.15		2.95	2.75	2.15	1.35		2.90	2.65	2.15	1.35	2.35	2.25	2.20	1.35	24.0
26.0					2.85	2.65	2.10		2.80	2.60	2.10			2.70	2.55	2.10		2.00	1.95	1.95	1.30	26.0
28.0					2.55	2.55	2.05		2.40	2.45	2.05			2.15	2.40	2.05		1.75	1.70	1.75		28.0
30.0					2.10	2.25	2.00		1.90	2.15	2.00			1.70	1.95	2.00		1.50	1.50	1.50		30.0
32.0					1.70	1.85			1.50	1.70	1.80			1.30	1.50	1.65		1.25	1.30	1.30		32.0
34.0					1.30	1.45			1.15	1.35				0.95	1.10	1.20		0.90	1.10	1.15		34.0
36.0					1.00	1.10			0.85	1.00				0.60	0.80			0.60	0.75	0.85		36.0
38.0					0.75	0.80			0.60	0.70					0.50				0.45			38.0
40.0					0.50					0.45												40.0
42.0																						42.0
44.0																						44.0
46.0																						46.0
48.0																						48.0
50.0																						50.0
52.0																						52.0
54.0																						54.0
55.0																						55.0
56.0																						56.0
1	0	0	0	0	0	0	0	0	46	46	46	46		92	92	92	92	100	100	100	100	1
2	0	0	0	0	92	92	92	92	92	92	92	92		92	92	92	92	100	100	100	100	2
3	0	0	0	0	92	92	92	92	92	92	92	92		92	92	92	92	100	100	100	100	3
4	0	0	0	0	92	92	92	92	92	92	92	92		92	92	92	92	100	100	100	100	4
5	0	0	0	0	92	92	92	92	92	92	92	92		92	92	92	92	100	100	100	100	5
ID	1	1	1	1	9	9	9	9	10	10	10	10		11	11	11	11	22	22	22	22	ID
[DEG]	28~84	35~84	54~84	68~84	26~84	35~84	54~84	68~84	39~84	38~84	54~84	67~84		47~84	48~84	55~84	69~84	50~84	51~84	55~84	68~84	[DEG]
	1	1	1	1	1	1	1	1	1	1	1	1		1	1	1	1	1	1	1	1	
	5t	5t	5t	5t	5t	5t	5t	5t	5t	5t	5t	5t		5t	5t	5t	5t	5t	5t	5t	5t	

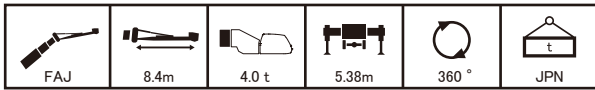

m	10.2				38.2				41.7				45.2				48.0				m		
	5	25	45	60	5	25	45	60	5	25	45	60	5	25	45	60	5	25	45	60			
2.0	2.80																					2.0	
3.0	2.80																					3.0	
4.0	2.80																					4.0	
5.0	2.80																					5.0	
6.0	2.80																					6.0	
7.0	2.80	2.60																				7.0	
8.0	2.80	2.45			2.80				2.80					2.80								8.0	
9.0	2.80	2.30			2.80				2.80					2.80								9.0	
10.0	2.65	2.20	1.75		2.80				2.80					2.80				2.65				10.0	
11.0	2.50	2.10	1.65		2.80				2.80					2.80				2.65				11.0	
12.0	2.35	2.00	1.55	0.90	2.80				2.80					2.75				2.60				12.0	
13.0	2.25	1.95	1.50	0.85	2.80	2.20			2.80	2.20				2.70				2.55				13.0	
14.0	2.10	1.85	1.45	0.85	2.80	2.15			2.75	2.15				2.65	2.15			2.55				14.0	
16.0	1.95	1.75	1.35		2.70	2.05	1.55		2.65	2.05	1.55			2.60	2.05			2.45	2.05			16.0	
18.0	1.80	1.65			2.55	2.00	1.50	0.80	2.55	2.00	1.50	0.80		2.50	2.00	1.50	0.80	2.40	1.95	1.50		18.0	
20.0		1.70			2.45	1.90	1.40	0.80	2.45	1.90	1.45	0.80		2.45	1.90	1.45	0.80	2.35	1.90	1.45	0.80	20.0	
22.0					2.30	1.85	1.35	0.75	2.35	1.85	1.35	0.75		2.35	1.85	1.40	0.75	2.30	1.85	1.40	0.75	22.0	
24.0					2.20	1.80	1.30	0.75	2.25	1.80	1.35	0.75		2.25	1.80	1.35	0.75	2.25	1.80	1.35	0.75	24.0	
26.0					2.10	1.75	1.25	0.75	2.15	1.75	1.30	0.75		2.15	1.75	1.30	0.75	2.00	1.75	1.30	0.75	26.0	
28.0					2.00	1.70	1.25		2.05	1.70	1.25	0.75		2.10	1.75	1.25	0.70	1.75	1.75	1.25	0.70	28.0	
30.0					1.95	1.70	1.20		2.00	1.70	1.20			2.00	1.70	1.20	0.70	1.55	1.55	1.20	0.70	30.0	
32.0					1.90	1.65	1.20		1.90	1.65	1.20			1.85	1.65	1.20		1.35	1.35	1.20		32.0	
34.0					1.70	1.60	1.15		1.55	1.65	1.15			1.30	1.60	1.15		1.15	1.20	1.15		34.0	
36.0					1.40	1.60			1.20	1.45	1.15			1.00	1.25	1.15		0.95	1.00	1.05		36.0	
38.0					1.10	1.30			0.95	1.15				0.70	0.95	1.10		0.65	0.90	0.90		38.0	
40.0					0.85	1.00			0.70	0.90					0.70	0.80		0.40	0.65	0.80		40.0	
42.0					0.65	0.75				0.65									0.40				42.0
44.0																							44.0
46.0																							46.0
48.0																							48.0
50.0																							50.0
52.0																							52.0
54.0																							54.0
55.0																							55.0
56.0																							56.0
1	0	0	0	0	0	0	0	0	46	46	46	46		92	92	92	92	100	100	100	100	1	
2	0	0	0	0	92	92	92	92	92	92	92	92											



m		10.2	10.2	10.2	10.2	38.2	38.2	38.2	38.2	41.7	41.7	41.7	41.7	45.2	45.2	45.2	45.2	48.0	48.0	48.0	48.0	m
°		5	25	45	60	5	25	45	60	5	25	45	60	5	25	45	60	5	25	45	60	°
2.0	4.00																					2.0
3.0	4.00																					3.0
4.0	4.00	4.00																				4.0
5.0	4.00	4.00																				5.0
6.0	4.00	4.00	3.00																			6.0
7.0	4.00	4.00	2.85			4.00				4.00												7.0
8.0	4.00	4.00	2.70	1.60		4.00				4.00				4.00				4.00				8.0
9.0	4.00	4.00	2.55	1.55	4.00					4.00				4.00				4.00				9.0
10.0	4.00	3.90	2.45	1.50	4.00	4.00				4.00	4.00			4.00				4.00				10.0
11.0	4.00	3.70	2.35		4.00	4.00				4.00	4.00			4.00	4.00			4.00				11.0
12.0	4.00	3.50	2.30		4.00	4.00	2.65	1.55		4.00	4.00	2.65		4.00	3.95			4.00	3.70			12.0
13.0	4.00	3.35			4.00	4.00	2.60	1.50	4.00	4.00	3.90	2.60	1.50	4.00	3.80	2.60		3.95	3.55			13.0
14.0	4.00	3.20			4.00	3.85	2.55	1.50	4.00	4.00	3.75	2.55	1.50	4.00	3.65	2.55	1.50	3.85	3.45	2.60	1.50	14.0
16.0					4.00	3.60	2.45	1.45	3.95	3.50	2.45	1.45	3.85	3.40	2.45	1.45		3.55	3.20	2.50	1.45	16.0
18.0					3.75	3.35	2.35	1.40	3.65	3.25	2.35	1.40	3.50	3.20	2.40	1.40		3.30	3.05	2.40	1.40	18.0
20.0					3.30	3.15	2.25	1.40	3.10	3.05	2.30	1.40	2.75	3.00	2.30	1.40		2.65	2.85	2.30	1.40	20.0
22.0					2.60	2.90	2.20	1.35	2.40	2.80	2.20	1.35	2.20	2.15	2.25	1.35		2.00	2.40	2.25	1.35	22.0
24.0					2.05	2.30	2.15		1.85	2.20	2.15	1.35		1.55	1.90	2.15	1.35	1.45	1.80	2.10	1.35	24.0
26.0					1.60	1.80	1.95		1.40	1.65	1.85			1.10	1.40	1.60		1.00	1.35	1.55	1.30	26.0
28.0					1.15	1.40	1.50		1.00	1.25	1.40			0.70	0.95	1.15			0.90	1.10		28.0
30.0					0.80	1.00	1.10		0.65	0.85	1.00				0.75							30.0
32.0					0.50	0.65				0.55	0.65											32.0
34.0																						34.0
36.0																						36.0
38.0																						38.0
40.0																						40.0
42.0																						42.0
44.0																						44.0
46.0																						46.0
48.0																						48.0
50.0																						50.0
52.0																						52.0
54.0																						54.0
55.0																						55.0
56.0																						56.0
	1	0	0	0	0	0	0	0	0	46	46	46	46	92	92	92	92	100	100	100	100	1
	2	0	0	0	0	92	92	92	92	92	92	92	92	92	92	92	92	100	100	100	100	2
	3	0	0	0	0	92	92	92	92	92	92	92	92	92	92	92	92	100	100	100	100	3
	4	0	0	0	0	92	92	92	92	92	92	92	92	92	92	92	92	100	100	100	100	4
	5	0	0	0	0	92	92	92	92	92	92	92	92	92	92	92	92	100	100	100	100	5
ID	1	1	1	1	1	9	9	9	9	10	10	10	10	11	11	11	11	22	22	22	22	ID
	[DEG]	28~84	35~84	54~84	68~84	45~84	48~84	54~84	68~84	52~84	53~84	54~84	67~84	58~84	62~84	61~84	69~84	63~84	64~84	65~84	68~84	[DEG]
		1	1	1	1	1	1	1	1	1	1	1	1	1	1	1	1	1	1	1	1	
		5t	5t	5t	5t	5t	5t	5t	5t	5t	5t	5t	5t	5t	5t	5t	5t	5t	5t	5t	5t	

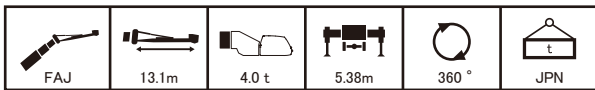

m		10.2	10.2	10.2	10.2	38.2	38.2	38.2	38.2	41.7	41.7	41.7	41.7	45.2	45.2	45.2	45.2	48.0	48.0	48.0	48.0	m
°		5	25	45	60	5	25	45	60	5	25	45	60	5	25	45	60	5	25	45	60	°
2.0	2.80																					2.0
3.0	2.80																					3.0
4.0	2.80																					4.0
5.0	2.80																					5.0
6.0	2.80																					6.0
7.0	2.80	2.60																				7.0
8.0	2.80	2.45				2.80				2.80												8.0
9.0	2.80	2.30				2.80				2.80				2.80								9.0
10.0	2.65	2.20	1.75			2.80				2.80				2.80				2.65				10.0
11.0	2.50	2.10	1.65			2.80				2.80				2.80				2.65				11.0
12.0	2.35	2.00	1.55	0.90		2.80				2.80				2.75				2.60				12.0
13.0	2.25	1.95	1.50	0.85	2.80	2.20				2.80	2.20			2.70				2.55				13.0
14.0	2.10	1.85	1.45	0.85	2.80	2.15				2.75	2.15			2.65	2.15			2.55				14.0
16.0	1.95	1.75	1.35			2.70	2.05	1.55		2.65	2.05	1.55		2.60	2.05			2.45	2.05			16.0
18.0	1.80	1.65				2.55	2.00	1.50	0.80	2.55	2.00	1.50	0.80	2.50	2.00	1.50	0.80	2.40	1.95	1.50		18.0
20.0		1.70				2.45	1.90	1.40	0.80	2.45	1.90	1.45	0.80	2.45	1.90	1.45	0.80	2.35	1.90	1.45	0.80	20.0
22.0						2.30	1.85	1.35	0.75	2.35	1.85	1.35	0.75	2.35	1.85	1.40	0.75	2.30	1.85	1.40	0.75	22.0
24.0						2.20	1.80	1.30	0.75	2.25	1.80	1.35	0.75	1.90	1.80	1.35	0.75	1.80	1.80	1.35	0.75	24.0
26.0						1.95	1.75	1.25	0.75	1.75	1.75	1.30	0.75	1.45	1.75	1.30	0.75	1.35	1.75	1.30	0.75	26.0
28.0						1.55	1.70	1.25		1.35	1.70	1.25	0.75	1.05	1.50	1.25	0.70	0.95	1.40	1.25	0.70	28.0
30.0						1.20	1.50	1.20		1.00	1.35	1.20		0.70	1.10	1.20	0.70		1.05	1.20	0.70	30.0
32.0						0.85	1.15	1.20		0.70	1.00	1.20							0.70	0.95		32.0
34.0						0.60	0.85	1.00			0.70	0.90										34.0
36.0							0.55					0.60										36.0
38.0																						38.0
40.0																						40.0
42.0																						42.0
44.0																						44.0
46.0																						46.0
48.0																						48.0
50.0																						50.0
52.0																						52.0
54.0																						54.0
55.0																						55.0
56.0																						56.0
	1	0	0	0	0	0	0	0	0	46	46	46	46	92	92	92	92	100	100	100	100	1

フルオートジブ

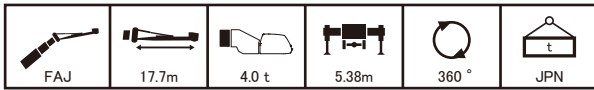

m		10.2	10.2	10.2	10.2	38.2	38.2	38.2	38.2	41.7	41.7	41.7	41.7	45.2	45.2	45.2	45.2	48.0	48.0	48.0	48.0	m	
°		5	25	45	60	5	25	45	60	5	25	45	60	5	25	45	60	5	25	45	60	°	
2.0																							2.0
3.0	1.50																						3.0
4.0	1.50																						4.0
5.0	1.50																						5.0
6.0	1.50																						6.0
7.0	1.50																						7.0
8.0	1.50					1.50																	8.0
9.0	1.50	1.25				1.50				1.50				1.45									9.0
10.0	1.45	1.15				1.50				1.50				1.45					1.35				10.0
11.0	1.35	1.10				1.50				1.45				1.40					1.35				11.0
12.0	1.25	1.05				1.45				1.45				1.40					1.35				12.0
13.0	1.20	1.00				1.45				1.40				1.35					1.30				13.0
14.0	1.15	0.95	0.85			1.40				1.40				1.35					1.30				14.0
16.0	1.00	0.90	0.80	0.55		1.35	1.00			1.30	1.00			1.30	1.00				1.25				16.0
18.0	0.95	0.85	0.75	0.50		1.30	0.95			1.25	0.95			1.25	0.95				1.20	0.95			18.0
20.0	0.85	0.80	0.75	0.50		1.20	0.90	0.75		1.20	0.90	0.75		1.20	0.90				1.15	0.90			20.0
22.0	0.80	0.75	0.70			1.15	0.90	0.75	0.50	1.15	0.90	0.75	0.50	1.15	0.90	0.75			1.15	0.90	0.75		22.0
24.0	0.75	0.75				1.10	0.85	0.70	0.45	1.10	0.85	0.70	0.45	1.10	0.85	0.70	0.45		1.10	0.85	0.70	0.45	24.0
26.0						1.05	0.85	0.70	0.45	1.05	0.85	0.70	0.45	1.05	0.85	0.70	0.45		1.05	0.85	0.70	0.45	26.0
28.0						1.00	0.80	0.70	0.45	1.00	0.80	0.70	0.45	1.05	0.80	0.70	0.45		1.00	0.80	0.70	0.45	28.0
30.0						0.95	0.80	0.70	0.45	0.95	0.80	0.70	0.45	1.00	0.80	0.70	0.45		0.95	0.80	0.70	0.45	30.0
32.0						0.90	0.75	0.70		0.95	0.75	0.70	0.40	0.70	0.75	0.70	0.40		0.75	0.70	0.40		32.0
34.0						0.85	0.75	0.70		0.75	0.75	0.70		0.75	0.70	0.70	0.40		0.75	0.70	0.40		34.0
36.0						0.65	0.75	0.70		0.50	0.75	0.70		0.60	0.70	0.70	0.40		0.65	0.70	0.40		36.0
38.0						0.45	0.70	0.70		0.60	0.70	0.70				0.60					0.65	0.40	38.0
40.0							0.50	0.60				0.55											40.0
42.0																							42.0
44.0																							44.0
46.0																							46.0
48.0																							48.0
50.0																							50.0
52.0																							52.0
54.0																							54.0
55.0																							55.0
56.0																							56.0
1	0	0	0	0	0	0	0	0	0	46	46	46	46	92	92	92	92	100	100	100	100	100	1
2	0	0	0	0	0	92	92	92	92	92	92	92	92	92	92	92	92	100	100	100	100	100	2
3	0	0	0	0	0	92	92	92	92	92	92	92	92	92	92	92	92	100	100	100	100	100	3
4	0	0	0	0	0	92	92	92	92	92	92	92	92	92	92	92	92	100	100	100	100	100	4
5	0	0	0	0	0	92	92	92	92	92	92	92	92	92	92	92	92	100	100	100	100	100	5
ID	1	1	1	1	1	9	9	9	9	10	10	10	10	11	11	11	11	22	22	22	22	22	ID
[DEG]	19~84	31~84	51~84	65~84	49~84	52~84	54~84	71~84	55~84	58~84	58~84	70~84	62~84	63~84	64~84	69~84	65~84	67~84	68~84	68~84	68~84	[DEG]	
	5t	5t	5t	5t	5t	5t	5t	5t	5t	5t	5t	5t	5t	5t	5t	5t	5t	5t	5t	5t	5t	5t	

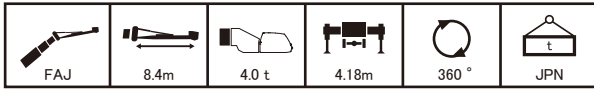

m		10.2	10.2	10.2	10.2	38.2	38.2	38.2	38.2	41.7	41.7	41.7	41.7	45.2	45.2	45.2	45.2	48.0	48.0	48.0	48.0	m	
°		5	25	45	60	5	25	45	60	5	25	45	60	5	25	45	60	5	25	45	60	°	
2.0	4.00																						2.0
3.0	4.00																						3.0
4.0	4.00	4.00																					4.0
5.0	4.00	4.00																					5.0
6.0	4.00	4.00	3.00																				6.0
7.0	4.00	4.00	2.85			4.00				4.00													7.0
8.0	4.00	4.00	2.70	1.60		4.00				4.00				4.00				4.00					8.0
9.0	4.00	4.00	2.55	1.55		4.00				4.00				4.00				4.00					9.0
10.0	4.00	3.90	2.45	1.50		4.00	4.00			4.00	4.00			4.00				4.00					10.0
11.0	4.00	3.70	2.35			4.00	4.00			4.00	4.00			4.00	4.00			4.00					11.0
12.0	4.00	3.50	2.30			4.00	4.00	2.65	1.55	4.00	4.00	2.65		4.00	3.95			4.00	3.70				12.0
13.0	4.00	3.35				4.00	4.00	2.60	1.50	4.00	4.00	2.60	1.50	4.00	3.80	2.60		3.95	3.55				13.0
14.0	4.00	3.20				4.00	3.85	2.55	1.50	4.00	3.75	2.55	1.50	3.75	3.65	2.55	1.50	3.60	3.45	2.60	1.50	1.40	14.0
16.0						3.40	3.60	2.45	1.45	3.10	3.50	2.45	1.45	2.75	3.35	2.45	1.45	2.65	3.20	2.50	1.45	1.40	16.0
18.0						2.60	3.00	2.35	1.40	2.35	2.80	2.35	1.40	2.00	2.50	2.40	1.40	1.90	2.40	2.40	1.40	1.40	18.0
20.0						1.95	2.30	2.25	1.40	1.70	2.10	2.30	1.40	1.35	1.80	2.15	1.40	1.30	1.70	2.05	1.40	1.40	20.0
22.0						1.40	1.70	1.95	1.35	1.15	1.50	1.80	1.35	1.25	1.50	1.35	1.35	1.15	1.45	1.35	1.35	1.35	22.0
24.0						0.95	1.25	1.45		0.75	1.05	1.25	1.35							0.95	1.05	1.40	24.0
26.0						0.55	0.80	1.00				0.80											26.0
28.0																							28.0
30.0								0.60															30.0
32.0																							32.0
34.0																							34.0
36.0																							36.0
38.0																							38.0
40.0																							40.0
42.0																							42.0
44.0																							44.0
46.0																							46.0
48.0																							48.0
50.0																							50.0
52.0																							52.0
54.0																							54.0
55.0																							55.0
56.0																							56.0
1	0	0	0	0	0	0	0	0	0	46	46	46	46	92	92	92	92	100	100	100	100	100	1
2	0	0	0	0	0	92	92	9															

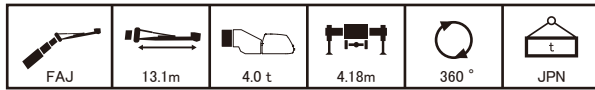

m		10.2	10.2	10.2	10.2	38.2	38.2	38.2	38.2	41.7	41.7	41.7	41.7	45.2	45.2	45.2	45.2	48.0	48.0	48.0	48.0	m
°		5	25	45	60	5	25	45	60	5	25	45	60	5	25	45	60	5	25	45	60	°
2.0	2.80																					2.0
3.0	2.80																					3.0
4.0	2.80																					4.0
5.0	2.80																					5.0
6.0	2.80																					6.0
7.0	2.80	2.60																				7.0
8.0	2.80	2.45				2.80				2.80												8.0
9.0	2.80	2.30				2.80				2.80					2.80							9.0
10.0	2.65	2.20				2.80				2.80				2.80						2.65		10.0
11.0	2.50	2.10	1.75			2.80				2.80				2.80					2.65			11.0
12.0	2.35	2.00	1.55	0.90		2.80				2.80				2.75					2.60			12.0
13.0	2.25	1.95	1.50	0.85	2.80	2.20				2.80	2.20			2.70					2.55			13.0
14.0	2.10	1.85	1.45	0.85	2.80	2.15				2.75	2.15			2.65	2.15				2.55			14.0
16.0	1.95	1.75	1.35			2.70	2.05	1.55		2.65	2.05	1.55		2.60	2.05				2.45	2.05		16.0
18.0	1.80	1.65				2.55	2.00	1.50	0.80	2.55	2.00	1.50	0.80	2.35	2.00	1.50	0.80	2.25	1.95	1.50		18.0
20.0	1.70					2.30	1.90	1.40	0.80	2.05	1.90	1.45	0.80	1.75	1.90	1.45	0.80	1.65	1.90	1.45	0.80	20.0
22.0						1.75	1.85	1.35	0.75	1.55	1.85	1.35	0.75	1.20	1.80	1.40	0.75	1.15	1.75	1.40	0.75	22.0
24.0						1.30	1.75	1.30	0.75	1.10	1.60	1.35	0.75		1.30	1.35	0.75		1.25	1.35	0.75	24.0
26.0						0.95	1.35	1.25	0.75	0.70	1.15	1.30	0.75		0.90	1.25	0.75		1.20	1.35	0.75	26.0
28.0						0.60	0.95	1.20			0.80	1.05	0.75			0.85	0.70				0.70	28.0
30.0							0.65	0.85				0.70										30.0
32.0								0.55														32.0
34.0																						34.0
36.0																						36.0
38.0																						38.0
40.0																						40.0
42.0																						42.0
44.0																						44.0
46.0																						46.0
48.0																						48.0
50.0																						50.0
52.0																						52.0
54.0																						54.0
55.0																						55.0
56.0																						56.0
1	0	0	0	0	0	0	0	0	0	46	46	46	46	92	92	92	92	100	100	100	100	1
2	0	0	0	0	0	92	92	92	92	92	92	92	92	92	92	92	92	100	100	100	100	2
3	0	0	0	0	0	92	92	92	92	92	92	92	92	92	92	92	92	100	100	100	100	3
4	0	0	0	0	0	92	92	92	92	92	92	92	92	92	92	92	92	100	100	100	100	4
5	0	0	0	0	0	92	92	92	92	92	92	92	92	92	92	92	92	100	100	100	100	5
ID	1	1	1	1	1	9	9	9	9	10	10	10	10	11	11	11	11	22	22	22	22	ID
[DEG]	0~84	84~84	57~84	71~84	57~84	59~84	59~84	59~84	69~84	62~84	64~84	65~84	68~84	69~84	69~84	69~84	70~84	70~84	72~84	73~84	72~84	[DEG]
5t	5t	5t	5t	5t	5t	5t	5t	5t	5t	5t	5t	5t	5t	5t	5t	5t	5t	5t	5t	5t	5t	5t

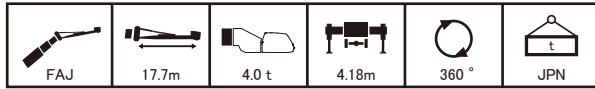

m		10.2	10.2	10.2	10.2	38.2	38.2	38.2	38.2	41.7	41.7	41.7	41.7	45.2	45.2	45.2	45.2	48.0	48.0	48.0	48.0	m
°		5	25	45	60	5	25	45	60	5	25	45	60	5	25	45	60	5	25	45	60	°
2.0																						2.0
3.0	1.50																					3.0
4.0	1.50																					4.0
5.0	1.50																					5.0
6.0	1.50																					6.0
7.0	1.50																					7.0
8.0	1.50					1.50				1.50				1.45								8.0
9.0	1.50	1.25				1.50				1.50				1.45								9.0
10.0	1.45	1.15				1.50				1.50				1.45					1.35			10.0
11.0	1.35	1.10				1.50				1.45				1.40					1.35			11.0
12.0	1.25	1.05				1.45				1.45				1.40					1.35			12.0
13.0	1.20	1.00				1.45				1.40				1.35					1.30			13.0
14.0	1.15	0.95	0.85			1.40				1.40				1.35					1.30			14.0
16.0	1.00	0.90	0.80	0.55		1.35	1.00			1.30	1.00			1.30	1.00				1.25			16.0
18.0	0.95	0.85	0.75	0.50		1.30	0.95			1.25	0.95			1.25	0.95				1.20	0.95		18.0
20.0	0.85	0.80	0.75	0.50		1.20	0.90	0.75		1.20	0.90	0.75		1.20	0.90				1.15	0.90		20.0
22.0	0.80	0.75	0.70			1.15	0.90	0.75	0.50	1.15	0.90	0.75	0.50	1.15	0.90	0.75			1.15	0.90	0.75	22.0
24.0	0.75	0.75				1.10	0.85	0.70	0.45	1.10	0.85	0.70	0.45	1.10	0.85	0.70	0.45	1.00	0.85	0.70	0.45	24.0
26.0						1.05	0.85	0.70	0.45	1.00	0.85	0.70	0.45	1.10	0.85	0.70	0.45		0.85	0.70	0.45	26.0
28.0						0.90	0.80	0.70	0.45	0.70	0.80	0.70	0.45		0.80	0.70	0.45		0.80	0.70	0.45	28.0
30.0						0.65	0.80	0.70	0.45		0.80	0.70	0.45			0.70	0.45				0.45	30.0
32.0							0.75	0.70			0.60	0.70	0.40			0.70	0.40				0.40	32.0
34.0							0.50	0.70				0.60										34.0
36.0								0.50														36.0
38.0																						38.0
40.0																						40.0
42.0																						42.0
44.0																						44.0
46.0																						46.0
48.0																						48.0
50.0																						50.0
52.0																						52.0
54.0																						54.0
55.0																						55.0
56.0																						56.0
1	0	0	0	0	0	0	0	0	0	46	46	46	46	92	92	92	92	100	100	100	100	1
2	0	0	0	0	0	92	92	92	92	92	92	92	92	92	92	92	92	100	100	100	100	2
3	0	0	0	0	0	92	92	92	92	92	92	92	92	92	92	92	92	100	100	100	100	3
4	0	0	0	0	0	92	92	92	92	92	92	92	92	92	92	92	92	100	100	100	100	4
5	0	0	0	0	0	92	92	92	92	92	92	92	92	92	92	92	92	100	100	100	100	5
ID	1	1	1	1	1	9	9	9														

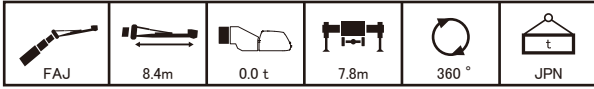

m	10.2				38.2				41.7				45.2				48.0				m		
	5	25	45	60	5	25	45	60	5	25	45	60	5	25	45	60	5	25	45	60	°		
2.0	4.00																					2.0	
3.0	4.00																					3.0	
4.0	4.00	4.00																				4.0	
5.0	4.00	4.00																				5.0	
6.0	4.00	4.00	3.00																			6.0	
7.0	4.00	4.00	2.85		4.00				4.00													7.0	
8.0	4.00	4.00	2.70	1.60	4.00				4.00										4.00			8.0	
9.0	4.00	4.00	2.55	1.55	4.00				4.00				4.00						4.00			9.0	
10.0	4.00	3.90	2.45	1.50	4.00	4.00			4.00	4.00			4.00						4.00			10.0	
11.0	4.00	3.70	2.35		4.00	4.00			4.00	4.00			4.00	4.00					4.00			11.0	
12.0	4.00	3.50	2.30		4.00	4.00	2.65	1.55	4.00	4.00	2.65		4.00	3.95					4.00	3.70		12.0	
13.0	4.00	3.35			4.00	4.00	2.60	1.50	4.00	3.90	2.60	1.50	4.00	3.80	2.60				3.95	3.55		13.0	
14.0	4.00	3.20			4.00	3.85	2.55	1.50	4.00	3.75	2.55	1.50	4.00	3.65	2.55	1.50			3.85	3.45	2.60	1.50	14.0
16.0					4.00	3.60	2.45	1.45	3.95	3.50	2.45	1.45	3.85	3.40	2.45	1.45			3.55	3.20	2.50	1.45	16.0
18.0					3.75	3.35	2.35	1.40	3.65	3.25	2.35	1.40	3.55	3.20	2.40	1.40			3.30	3.05	2.40	1.40	18.0
20.0					3.50	3.15	2.25	1.40	3.40	3.05	2.30	1.40	3.30	3.00	2.30	1.40			3.05	2.85	2.30	1.40	20.0
22.0					3.25	2.95	2.20	1.35	3.20	2.90	2.20	1.35	3.10	2.80	2.25	1.35			2.70	2.60	2.25	1.35	22.0
24.0					3.05	2.80	2.15		2.90	2.75	2.15	1.35	2.65	2.65	2.15	1.35			2.35	2.25	2.20	1.35	24.0
26.0					2.50	2.65	2.10		2.35	2.60	2.10		2.10	2.40	2.10				2.00	1.95	1.95	1.30	26.0
28.0					2.00	2.20	2.05		1.85	2.10	2.05		1.60	1.90	2.05				1.55	1.70	1.75		28.0
30.0					1.60	1.80	1.85		1.45	1.65	1.80		1.20	1.45	1.60				1.10	1.40	1.50		30.0
32.0					1.20	1.40			1.05	1.25	1.35		0.80	1.05	1.15				0.75	1.00	1.15		32.0
34.0					0.90	1.00			0.75	0.90				0.70	0.80					0.65	0.80		34.0
36.0					0.60	0.70			0.45	0.60													36.0
38.0						0.45																	38.0
40.0																							40.0
42.0																							42.0
44.0																							44.0
46.0																							46.0
48.0																							48.0
50.0																							50.0
52.0																							52.0
54.0																							54.0
55.0																							55.0
56.0																							56.0
1	0	0	0	0	0	0	0	0	46	46	46	46	92	92	92	92	100	100	100	100	100	1	
2	0	0	0	0	92	92	92	92	92	92	92	92	92	92	92	92	100	100	100	100	100	2	
3	0	0	0	0	92	92	92	92	92	92	92	92	92	92	92	92	100	100	100	100	100	3	
4	0	0	0	0	92	92	92	92	92	92	92	92	92	92	92	92	100	100	100	100	100	4	
5	0	0	0	0	92	92	92	92	92	92	92	92	92	92	92	92	100	100	100	100	100	5	
ID	1	1	1	1	9	9	9	9	10	10	10	10	11	11	11	11	22	22	22	22	22	ID	
[DEG]	28~84	35~84	54~84	68~84	37~84	35~84	54~84	68~84	42~84	46~84	54~84	67~84	53~84	54~84	55~84	69~84	56~84	56~84	58~84	68~84	[DEG]		
	1	1	1	1	1	1	1	1	1	1	1	1	1	1	1	1	1	1	1	1	1		
	5t	5t	5t	5t	5t	5t	5t	5t	5t	5t	5t	5t	5t	5t	5t	5t	5t	5t	5t	5t	5t		

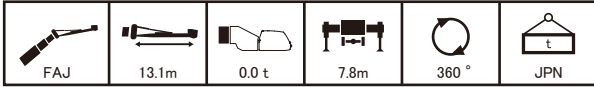

m	10.2				38.2				41.7				45.2				48.0				m		
	5	25	45	60	5	25	45	60	5	25	45	60	5	25	45	60	5	25	45	60	°		
2.0	2.80																					2.0	
3.0	2.80																					3.0	
4.0	2.80																					4.0	
5.0	2.80																					5.0	
6.0	2.80																					6.0	
7.0	2.80	2.60																				7.0	
8.0	2.80	2.45			2.80				2.80													8.0	
9.0	2.80	2.30			2.80				2.80				2.80									9.0	
10.0	2.65	2.20	1.75		2.80				2.80				2.80						2.65			10.0	
11.0	2.50	2.10	1.65		2.80				2.80				2.80						2.65			11.0	
12.0	2.35	2.00	1.55	0.90	2.80				2.80				2.75						2.60			12.0	
13.0	2.25	1.95	1.50	0.85	2.80	2.20			2.80	2.20			2.70						2.55			13.0	
14.0	2.10	1.85	1.45	0.85	2.80	2.15			2.75	2.15			2.65	2.15					2.55			14.0	
16.0	1.95	1.75	1.35		2.70	2.05	1.55		2.65	2.05	1.55		2.60	2.05					2.45	2.05		16.0	
18.0	1.80	1.65			2.55	2.00	1.50	0.80	2.55	2.00	1.50	0.80	2.50	2.00	1.50	0.80			2.40	1.95	1.50	18.0	
20.0	1.70				2.45	1.90	1.40	0.80	2.45	1.90	1.45	0.80	2.45	1.90	1.45	0.80			2.35	1.90	1.45	0.80	20.0
22.0					2.30	1.85	1.35	0.75	2.35	1.85	1.35	0.75	2.35	1.85	1.40	0.75			2.30	1.85	1.40	0.75	22.0
24.0					2.20	1.80	1.30	0.75	2.25	1.80	1.35	0.75	2.25	1.80	1.35	0.75			2.25	1.80	1.35	0.75	24.0
26.0					2.10	1.75	1.25	0.75	2.15	1.75	1.30	0.75	2.15	1.75	1.30	0.75			2.00	1.75	1.30	0.75	26.0
28.0					2.00	1.70	1.25		2.05	1.70	1.25	0.75	2.00	1.75	1.25	0.70			1.75	1.75	1.25	0.70	28.0
30.0					1.95	1.70	1.20		1.80	1.70	1.20		1.55	1.70	1.20	0.70			1.50	1.55	1.20	0.70	30.0
32.0					1.60	1.65	1.20		1.45	1.65	1.20		1.20	1.55	1.20				1.10	1.35	1.20		32.0
34.0					1.25	1.50	1.15		1.10	1.40	1.15		0.85	1.20	1.15				0.80	1.15	1.15		34.0
36.0					0.95	1.20			0.80	1.05	1.15		0.55	0.85	1.05					0.80	1.00		36.0
38.0					0.70	0.90			0.55	0.75				0.55	0.70								38.0
40.0																							40.0
42.0																							42.0
44.0																							44.0
46.0																							46.0
48.0																							48.0
50.0																							50.0
52.0																							52.0
54.0																							54.0
55.0																							55.0
56.0																							56.0
1	0	0	0	0	0	0	0	0	46	46	46	46	92	92	92	92	100	100	100	100	100	1	
2	0	0	0	0	92	92	92	92	92	92	92	92	92	92	92	92	100	100	100	100	100	2	
3																							

フルオートジブ

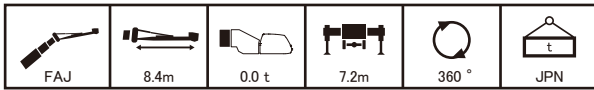

	m	10.2				38.2				41.7				45.2				48.0				m		
		5	25	45	60	5	25	45	60	5	25	45	60	5	25	45	60	5	25	45	60			
2.0	4.00																						2.0	
3.0	4.00																							3.0
4.0	4.00	4.00																						4.0
5.0	4.00	4.00																						5.0
6.0	4.00	4.00	3.00																					6.0
7.0	4.00	4.00	2.85		4.00					4.00														7.0
8.0	4.00	4.00	2.70	1.60	4.00					4.00					4.00					4.00				8.0
9.0	4.00	4.00	2.55	1.55	4.00					4.00					4.00					4.00				9.0
10.0	4.00	3.90	2.45	1.50	4.00	4.00				4.00	4.00				4.00				4.00				10.0	
11.0	4.00	3.70	2.35		4.00	4.00				4.00	4.00				4.00	4.00			4.00				11.0	
12.0	4.00	3.50	2.30		4.00	4.00	2.65	1.55		4.00	4.00	2.65			4.00	3.95			4.00	3.70			12.0	
13.0	4.00	3.35			4.00	4.00	2.60	1.50		4.00	3.90	2.60	1.50		4.00	3.80	2.60		3.95	3.55			13.0	
14.0	4.00	3.20			4.00	3.85	2.55	1.50		4.00	3.75	2.55	1.50		4.00	3.65	2.55	1.50	3.85	3.45	2.60	1.50	14.0	
16.0					4.00	3.60	2.45	1.45		3.95	3.50	2.45	1.45		3.85	3.40	2.45	1.45	3.55	3.20	2.50	1.45	16.0	
18.0					4.00	3.35	2.35	1.40		3.65	3.25	2.35	1.40		3.55	3.20	2.40	1.40	3.30	3.05	2.40	1.40	18.0	
20.0					3.50	3.15	2.25	1.40		3.40	3.05	2.30	1.40		3.30	3.00	2.30	1.40	3.05	2.85	2.30	1.40	20.0	
22.0					3.20	2.95	2.20	1.35		3.05	2.90	2.20	1.35		2.75	2.80	2.25	1.35	2.65	2.60	2.25	1.35	22.0	
24.0					2.55	2.80	2.15			2.40	2.70	2.15	1.35		2.10	2.45	2.15	1.35	2.05	2.25	2.20	1.35	24.0	
26.0					2.05	2.25	2.10			1.90	2.15	2.10			1.60	1.90	2.10		1.50	1.85	1.95	1.30	26.0	
28.0					1.60	1.80	1.90			1.45	1.70	1.80			1.15	1.45	1.60		1.05	1.35	1.55		28.0	
30.0					1.20	1.40	1.50			1.05	1.25	1.40			0.75	1.00	1.20		0.70	0.95	1.15		30.0	
32.0					0.85	1.00				0.70	0.90	1.00				0.65	0.80				0.75		32.0	
34.0					0.55	0.70				0.40	0.55												34.0	
36.0						0.40																	36.0	
38.0																							38.0	
40.0																							40.0	
42.0																							42.0	
44.0																							44.0	
46.0																							46.0	
48.0																							48.0	
50.0																							50.0	
52.0																							52.0	
54.0																							54.0	
55.0																							55.0	
56.0																							56.0	
	1	0	0	0	0	0	0	0	0	46	46	46	46		92	92	92	92		100	100	100	100	1
	2	0	0	0	0	92	92	92	92	92	92	92	92		92	92	92	92		100	100	100	100	2
	3	0	0	0	0	92	92	92	92	92	92	92	92		92	92	92	92		100	100	100	100	3
	4	0	0	0	0	92	92	92	92	92	92	92	92		92	92	92	92		100	100	100	100	4
	5	0	0	0	0	92	92	92	92	92	92	92	92		92	92	92	92		100	100	100	100	5
	ID	1	1	1	1	9	9	9	9	10	10	10	10		11	11	11	11		22	22	22	22	ID
	[DEG]	28~84	35~84	54~84	68~84	41~84	40~84	54~84	68~84	46~84	49~84	54~84	67~84		56~84	57~84	58~84	69~84		58~84	61~84	60~84	68~84	[DEG]
		1	1	1	1	1	1	1	1	1	1	1	1		1	1	1	1		1	1	1	1	
		5t	5t	5t	5t	5t	5t	5t	5t	5t	5t	5t	5t		5t	5t	5t	5t		5t	5t	5t	5t	

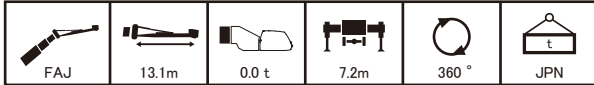

	m	10.2				38.2				41.7				45.2				48.0				m		
		5	25	45	60	5	25	45	60	5	25	45	60	5	25	45	60	5	25	45	60			
2.0	2.80																							2.0
3.0	2.80																							3.0
4.0	2.80																							4.0
5.0	2.80																							5.0
6.0	2.80																							6.0
7.0	2.80	2.60																						7.0
8.0	2.80	2.45								2.80														8.0
9.0	2.80	2.30								2.80						2.80								9.0
10.0	2.65	2.20	1.75							2.80						2.80								10.0
11.0	2.50	2.10	1.65							2.80						2.80								11.0
12.0	2.35	2.00	1.55	0.90						2.80						2.75								12.0
13.0	2.25	1.95	1.50	0.85	2.80	2.20				2.80	2.20					2.70								13.0
14.0	2.10	1.85	1.45	0.85	2.80	2.15				2.75	2.15					2.65	2.15							14.0
16.0	1.95	1.75	1.35							2.70	2.05	1.55				2.60	2.05							16.0
18.0	1.80	1.65								2.55	2.00	1.50	0.80		2.50	2.00	1.50	0.80		2.40	1.95	1.50		18.0
20.0		1.70								2.45	1.90	1.40	0.80		2.45	1.90	1.45	0.80		2.35	1.90	1.45	0.80	20.0
22.0										2.30	1.85	1.35	0.75		2.35	1.85	1.40	0.75		2.30	1.85	1.40	0.75	22.0
24.0										2.20	1.80	1.30	0.75		2.25	1.80	1.35	0.75		2.25	1.80	1.35	0.75	24.0
26.0										2.10	1.75	1.25	0.75		2.15	1.75	1.30	0.75		2.10	1.75	1.30	0.75	26.0
28.0										1.95	1.70	1.25			1.80	1.70	1.25	0.75		1.50	1.75	1.25	0.70	28.0
30.0										1.55	1.70	1.20			1.40	1.70	1.20			1.15	1.55	1.20	0.70	30.0
32.0										1.25	1.50	1.20			1.05	1.40	1.20			0.80	1.15	1.20		32.0
34.0										0.95	1.15	1.15			0.75	1.05	1.15				0.85	1.05		34.0
36.0										0.65	0.85				0.50	0.75	0.90				0.70			36.0
38.0											0.60					0.50								38.0
40.0																								40.0
42.0																								42.0
44.0																								44.0
46.0																								46.0
48.0																								48.0
50.0																								50.0
52.0																								52.0
54.0																								54.0
55.0																								55.0
56.0																								56.0
	1																							

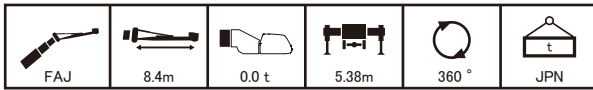

m		10.2	10.2	10.2	10.2	38.2	38.2	38.2	38.2	41.7	41.7	41.7	41.7	45.2	45.2	45.2	45.2	48.0	48.0	48.0	48.0	m	
°		5	25	45	60	5	25	45	60	5	25	45	60	5	25	45	60	5	25	45	60	°	
2.0	4.00																					2.0	
3.0	4.00																						3.0
4.0	4.00	4.00																					4.0
5.0	4.00	4.00																					5.0
6.0	4.00	4.00	3.00																				6.0
7.0	4.00	4.00	2.85		4.00				4.00														7.0
8.0	4.00	4.00	2.70	1.60	4.00				4.00				4.00					4.00					8.0
9.0	4.00	4.00	2.55	1.55	4.00				4.00				4.00					4.00					9.0
10.0	4.00	3.90	2.45	1.50	4.00	4.00			4.00	4.00			4.00					4.00					10.0
11.0	4.00	3.70	2.35		4.00	4.00			4.00	4.00			4.00	4.00				4.00					11.0
12.0	4.00	3.50	2.30		4.00	4.00	2.65	1.55	4.00	4.00	2.65		4.00	3.95				4.00	3.70				12.0
13.0	4.00	3.35			4.00	4.00	2.60	1.50	4.00	3.90	2.60	1.50	4.00	3.80	2.60			3.95	3.55				13.0
14.0	4.00	3.20			4.00	3.85	2.55	1.50	4.00	3.75	2.55	1.50	4.00	3.65	2.55	1.50		3.85	3.45	2.60	1.50		14.0
16.0					3.65	3.60	2.45	1.45	3.35	3.50	2.45	1.45	2.95	3.40	2.45	1.45		2.85	3.20	2.50	1.45		16.0
18.0					2.75	3.20	2.35	1.40	2.50	3.00	2.35	1.40	2.15	2.65	2.40	1.40		2.05	2.55	2.40	1.40		18.0
20.0					2.05	2.45	2.25	1.40	1.85	2.25	2.30	1.40	1.50	1.95	2.30	1.40		1.40	1.85	2.20	1.40		20.0
22.0					1.50	1.85	2.10	1.35	1.40	1.65	1.90	1.35	0.95	1.35	1.65	1.35		1.30	1.60	1.35	2.00		22.0
24.0					1.05	1.35	1.55		0.80	1.15	1.35	1.35				1.10	1.20			1.05	1.15		24.0
26.0					0.65	0.90	1.05			0.70	0.90												26.0
28.0						0.50	0.65																28.0
30.0																							30.0
32.0																							32.0
34.0																							34.0
36.0																							36.0
38.0																							38.0
40.0																							40.0
42.0																							42.0
44.0																							44.0
46.0																							46.0
48.0																							48.0
50.0																							50.0
52.0																							52.0
54.0																							54.0
55.0																							55.0
56.0																							56.0
1	0	0	0	0	0	0	0	0	0	46	46	46	46	92	92	92	92	100	100	100	100	1	
2	0	0	0	0	0	92	92	92	92	92	92	92	92	92	92	92	92	100	100	100	100	2	
3	0	0	0	0	0	92	92	92	92	92	92	92	92	92	92	92	92	100	100	100	100	3	
4	0	0	0	0	0	92	92	92	92	92	92	92	92	92	92	92	92	100	100	100	100	4	
5	0	0	0	0	0	92	92	92	92	92	92	92	92	92	92	92	92	100	100	100	100	5	
ID	1	1	1	1	1	9	9	9	9	10	10	10	10	11	11	11	11	22	22	22	22	ID	
[DEG]	28~84	35~84	54~84	68~84	55~84	55~84	57~84	68~84	61~84	61~84	63~84	67~84	66~84	69~84	68~84	69~84	69~84	70~84	70~84	71~84	71~84	[DEG]	
	1	1	1	1	1	1	1	1	1	1	1	1	1	1	1	1	1	1	1	1	1		
	5t	5t	5t	5t	5t	5t	5t	5t	5t	5t	5t	5t	5t	5t	5t	5t	5t	5t	5t	5t	5t		

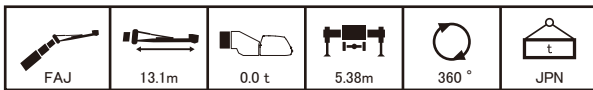

m		10.2	10.2	10.2	10.2	38.2	38.2	38.2	38.2	41.7	41.7	41.7	41.7	45.2	45.2	45.2	45.2	48.0	48.0	48.0	48.0	m	
°		5	25	45	60	5	25	45	60	5	25	45	60	5	25	45	60	5	25	45	60	°	
2.0	2.80																						2.0
3.0	2.80																						3.0
4.0	2.80																						4.0
5.0	2.80																						5.0
6.0	2.80																						6.0
7.0	2.80	2.60																					7.0
8.0	2.80	2.45			2.80				2.80														8.0
9.0	2.80	2.30			2.80				2.80				2.80										9.0
10.0	2.65	2.20	1.75		2.80				2.80				2.80					2.65					10.0
11.0	2.50	2.10	1.65		2.80				2.80				2.80					2.65					11.0
12.0	2.35	2.00	1.55	0.90	2.80				2.80				2.75					2.60					12.0
13.0	2.25	1.95	1.50	0.85	2.80	2.20			2.80	2.20			2.70					2.55					13.0
14.0	2.10	1.85	1.45	0.85	2.80	2.15			2.75	2.15			2.65	2.15				2.55					14.0
16.0	1.95	1.75	1.35		2.70	2.05	1.55		2.65	2.05	1.55		2.60	2.05				2.45	2.05				16.0
18.0	1.80	1.65			2.55	2.00	1.50	0.80	2.55	2.00	1.50	0.80	2.50	2.00	1.50	0.80		2.40	1.95	1.50			18.0
20.0	1.70				2.45	1.90	1.40	0.80	2.20	1.90	1.45	0.80	1.85	1.90	1.45	0.80		1.80	1.90	1.45	0.80		20.0
22.0					1.90	1.85	1.35	0.75	1.65	1.85	1.35	0.75	1.35	1.85	1.40	0.75		1.25	1.85	1.40	0.75		22.0
24.0					1.40	1.80	1.30	0.75	1.20	1.70	1.35	0.75	0.90	1.40	1.35	0.75		1.35	1.35	0.75			24.0
26.0					1.00	1.45	1.25	0.75	0.80	1.25	1.30	0.75		1.00	1.30	0.75			0.90	1.30	0.75		26.0
28.0					0.70	1.05	1.25			0.85	1.15	0.75			0.95	0.70				0.90	0.70		28.0
30.0						0.70	0.95				0.80												30.0
32.0							0.60																32.0
34.0																							34.0
36.0																							36.0
38.0																							38.0
40.0																							40.0
42.0																							42.0
44.0																							44.0
46.0																							46.0
48.0																							48.0
50.0																							50.0
52.0																							52.0
54.0																							54.0
55.0																							55.0
56.0																							56.0
1	0	0	0	0	0	0	0	0	0	46	46	46	46	92	92	92	92	100	100	100	100	1	
2	0	0	0	0	0	92	92	92	92	92	92	92	92	92	92	92	92	100	100	100	100	2	

フルオートジブ

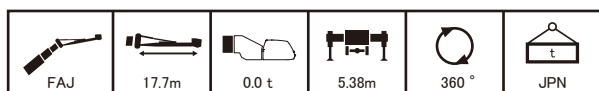

m		10.2	10.2	10.2	10.2	38.2	38.2	38.2	38.2	41.7	41.7	41.7	41.7	45.2	45.2	45.2	45.2	48.0	48.0	48.0	48.0	m		
°		5	25	45	60	5	25	45	60	5	25	45	60	5	25	45	60	5	25	45	60	°		
2.0																							2.0	
3.0	1.50																						3.0	
4.0	1.50																						4.0	
5.0	1.50																						5.0	
6.0	1.50																						6.0	
7.0	1.50																						7.0	
8.0	1.50					1.50																	8.0	
9.0	1.50	1.25				1.50				1.50					1.45								9.0	
10.0	1.45	1.15				1.50				1.50					1.45				1.35				10.0	
11.0	1.35	1.10				1.50				1.45					1.40				1.35				11.0	
12.0	1.25	1.05				1.45				1.45					1.40				1.35				12.0	
13.0	1.20	1.00				1.45				1.40					1.35				1.30				13.0	
14.0	1.15	0.95	0.85			1.40				1.40					1.35				1.30				14.0	
16.0	1.00	0.90	0.80	0.55		1.35	1.00			1.30	1.00				1.30	1.00			1.25				16.0	
18.0	0.95	0.85	0.75	0.50		1.30	0.95			1.25	0.95				1.25	0.95			1.20	0.95			18.0	
20.0	0.85	0.80	0.75	0.50		1.20	0.90	0.75		1.20	0.90	0.75			1.20	0.90			1.15	0.90			20.0	
22.0	0.80	0.75	0.70			1.15	0.90	0.75	0.50		1.15	0.90	0.75	0.50		1.15	0.90	0.75		1.15	0.90	0.75	22.0	
24.0	0.75	0.75				1.10	0.85	0.70	0.45		1.10	0.85	0.70	0.45		1.10	0.85	0.70	0.45		1.10	0.85	0.70	24.0
26.0						1.05	0.85	0.70	0.45		1.05	0.85	0.70	0.45		1.05	0.85	0.70	0.45		1.05	0.85	0.70	26.0
28.0						1.00	0.80	0.70	0.45		0.80	0.80	0.70	0.45		0.80	0.70	0.45		0.80	0.70	0.45	28.0	
30.0						0.70	0.80	0.70	0.45		0.80	0.80	0.70	0.45		0.80	0.70	0.45		0.80	0.70	0.45	30.0	
32.0							0.75	0.70				0.65	0.70	0.40			0.70	0.40					32.0	
34.0							0.55	0.70					0.70										34.0	
36.0								0.55															36.0	
38.0									0.55														38.0	
40.0																							40.0	
42.0																							42.0	
44.0																							44.0	
46.0																							46.0	
48.0																							48.0	
50.0																							50.0	
52.0																							52.0	
54.0																							54.0	
55.0																							55.0	
56.0																							56.0	
1	0	0	0	0	0	0	0	0	0	46	46	46	46	92	92	92	92	100	100	100	100	100	1	
2	0	0	0	0	0	92	92	92	92	92	92	92	92	92	92	92	92	100	100	100	100	100	2	
3	0	0	0	0	0	92	92	92	92	92	92	92	92	92	92	92	92	100	100	100	100	100	3	
4	0	0	0	0	0	92	92	92	92	92	92	92	92	92	92	92	92	100	100	100	100	100	4	
5	0	0	0	0	0	92	92	92	92	92	92	92	92	92	92	92	92	100	100	100	100	100	5	
ID	1	1	1	1	1	9	9	9	9	10	10	10	10	11	11	11	11	22	22	22	22	22	ID	
[DEG]	19~84	31~84	51~84	65~84	59~84	60~84	61~84	71~84	84~84	65~84	66~84	70~84	69~84	71~84	70~84	71~84	70~84	72~84	74~84	74~84	72~84	[DEG]		
5t	5t	5t	5t	5t	5t	5t	5t	5t	5t	5t	5t	5t	5t	5t	5t	5t	5t	5t	5t	5t	5t	5t	5t	

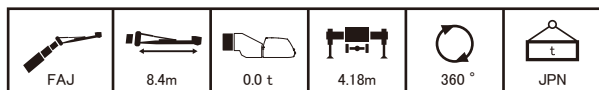

m		10.2	10.2	10.2	10.2	38.2	38.2	38.2	38.2	41.7	41.7	41.7	41.7	45.2	45.2	45.2	45.2	48.0	48.0	48.0	48.0	m	
°		5	25	45	60	5	25	45	60	5	25	45	60	5	25	45	60	5	25	45	60	°	
2.0	4.00																						2.0
3.0	4.00																						3.0
4.0	4.00	4.00																					4.0
5.0	4.00	4.00																					5.0
6.0	4.00	4.00	3.00																				6.0
7.0	4.00	4.00	2.85			4.00				4.00													7.0
8.0	4.00	4.00	2.70	1.60		4.00				4.00				4.00				4.00					8.0
9.0	4.00	4.00	2.55	1.55		4.00				4.00				4.00				4.00					9.0
10.0	4.00	3.90	2.45	1.50		4.00	4.00			4.00	4.00			4.00				4.00					10.0
11.0	4.00	3.70	2.35			4.00	4.00			4.00	4.00			3.90	4.00			3.80					11.0
12.0	4.00	3.50	2.30			4.00	4.00	2.65	1.55	3.65	4.00	2.65		3.25	3.95			3.15	3.70				12.0
13.0	4.00	3.35				3.40	4.00	2.60	1.50	3.10	3.75	2.60	1.50	2.70	3.40	2.60		2.60	3.30				13.0
14.0	3.65	3.20				2.85	3.45	2.55	1.50	2.60	3.20	2.55	1.50	2.20	2.90	2.55	1.50	2.10	2.80	2.60	1.50	1.40	14.0
16.0						2.00	2.55	2.45	1.45	1.75	2.30	2.45	1.45	1.40	2.00	2.45	1.45	1.90	2.35	1.45	1.45	1.60	16.0
18.0						1.35	1.80	2.15	1.40	1.10	1.60	1.95	1.40		1.30	1.65	1.40		1.60	1.40	1.40	1.80	18.0
20.0						0.80	1.20	1.50	1.40		1.00	1.30	1.40						1.60	1.40	1.40	2.00	20.0
22.0							0.70	0.95	1.05				0.90										22.0
24.0																							24.0
26.0																							26.0
28.0																							28.0
30.0																							30.0
32.0																							32.0
34.0																							34.0
36.0																							36.0
38.0																							38.0
40.0																							40.0
42.0																							42.0
44.0																							44.0
46.0																							46.0
48.0																							48.0
50.0																							50.0
52.0																							52.0
54.0																							54.0
55.0																							55.0
56.0																							56.0
1	0	0	0	0	0	0	0	0	0	46	46	46	46	92	92	92	92	100	100	100	100	100	1
2	0	0	0	0	0	92	92	92	92	92	92	92	92	92	92	92	92	100	100	100	100	100	2
3	0	0	0	0	0	92	92	92	92	92	92	92	92	92	92	92	92	100	100	100	100	100	3
4	0	0	0	0	0	92	92	92	92														

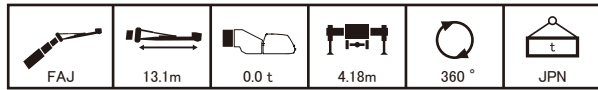

m	m																m				m			
	10.2	10.2	10.2	10.2	38.2	38.2	38.2	38.2	41.7	41.7	41.7	41.7	45.2	45.2	45.2	45.2	48.0	48.0	48.0	48.0		°		
°	5	25	45	60	5	25	45	60	5	25	45	60	5	25	45	60	5	25	45	60	°			
2.0	2.80																					2.0		
3.0	2.80																					3.0		
4.0	2.80																					4.0		
5.0	2.80																					5.0		
6.0	2.80																					6.0		
7.0	2.80	2.60																				7.0		
8.0	2.80	2.45			2.80				2.80													8.0		
9.0	2.80	2.30			2.80				2.80						2.80							9.0		
10.0	2.65	2.20			2.80				2.80						2.80						2.65	10.0		
11.0	2.50	2.10	1.75		2.80				2.80						2.80						2.65	11.0		
12.0	2.35	2.00	1.55	0.90	2.80				2.80						2.75						2.60	12.0		
13.0	2.25	1.95	1.50	0.85	2.80	2.20			2.80	2.20					2.70						2.55	13.0		
14.0	2.10	1.85	1.45	0.85	2.80	2.15			2.75	2.15					2.60	2.15					2.50	14.0		
16.0	1.95	1.75	1.35		2.40	2.05	1.55		2.15	2.05	1.55				1.80	2.05					1.70	16.0		
18.0	1.80	1.65			1.75	2.00	1.50	0.80	1.50	2.00	1.50	0.80			1.20	1.90	1.50	0.80			1.85	18.0		
20.0	1.70				1.20	1.80	1.40	0.80	1.00	1.60	1.45	0.80			1.30	1.45	0.80				1.25	20.0		
22.0					0.75	1.30	1.35	0.75		1.10	1.35	0.75				1.30	0.75				1.25	0.80	22.0	
24.0						0.85	1.20	0.75			1.05	0.75					0.75					1.25	0.75	24.0
26.0							0.80	0.75				0.75											0.75	26.0
28.0																								28.0
30.0																								30.0
32.0																								32.0
34.0																								34.0
36.0																								36.0
38.0																								38.0
40.0																								40.0
42.0																								42.0
44.0																								44.0
46.0																								46.0
48.0																								48.0
50.0																								50.0
52.0																								52.0
54.0																								54.0
55.0																								55.0
56.0																								56.0
1	0	0	0	0	0	0	0	0	46	46	46	46	92	92	92	92	100	100	100	100	1	1		
2	0	0	0	0	92	92	92	92	92	92	92	92	92	92	92	92	100	100	100	100	2	2		
3	0	0	0	0	92	92	92	92	92	92	92	92	92	92	92	92	100	100	100	100	3	3		
4	0	0	0	0	92	92	92	92	92	92	92	92	92	92	92	92	100	100	100	100	4	4		
5	0	0	0	0	92	92	92	92	92	92	92	92	92	92	92	92	100	100	100	100	5	5		
ID	1	1	1	1	9	9	9	9	10	10	10	10	11	11	11	11	22	22	22	22	ID	ID		
[DEG]	0~84	40~84	57~84	71~84	65~84	67~84	68~84	69~84	69~84	71~84	72~84	71~84	73~84	75~84	76~84	75~84	75~84	76~84	77~84	78~84	[DEG]	[DEG]		
5t	5t	5t	5t	5t	5t	5t	5t	5t	5t	5t	5t	5t	5t	5t	5t	5t	5t	5t	5t	5t	5t	5t	5t	

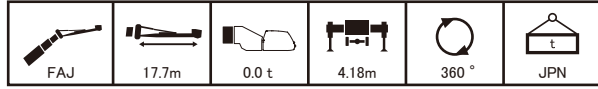

m	m																m				m		
	10.2	10.2	10.2	10.2	38.2	38.2	38.2	38.2	41.7	41.7	41.7	41.7	45.2	45.2	45.2	45.2	48.0	48.0	48.0	48.0		°	
°	5	25	45	60	5	25	45	60	5	25	45	60	5	25	45	60	5	25	45	60	°		
2.0																						2.0	
3.0	1.50																					3.0	
4.0	1.50																					4.0	
5.0	1.50																					5.0	
6.0	1.50																					6.0	
7.0	1.50																					7.0	
8.0	1.50				1.50				1.50													8.0	
9.0	1.50	1.25			1.50				1.50						1.45							9.0	
10.0	1.45	1.15			1.50				1.50						1.45						1.35	10.0	
11.0	1.35	1.10			1.50				1.45						1.40						1.35	11.0	
12.0	1.25	1.05			1.45				1.45						1.40						1.35	12.0	
13.0	1.20	1.00			1.45				1.40						1.35						1.30	13.0	
14.0	1.15	0.95	0.85		1.40				1.40						1.35						1.30	14.0	
16.0	1.00	0.90	0.80	0.55	1.35	1.00			1.30	1.00					1.30	1.00					1.25	16.0	
18.0	0.95	0.85	0.75	0.50	1.30	0.95			1.25	0.95					1.25	0.95					1.20	18.0	
20.0	0.85	0.80	0.75	0.50	1.20	0.90	0.75		1.20	0.90	0.75				0.90						0.90	20.0	
22.0	0.80	0.75	0.70		1.10	0.90	0.75	0.50	0.85	0.90	0.75	0.50			0.90	0.75					0.90	0.75	22.0
24.0	0.75	0.75			0.70	0.85	0.70	0.45		0.85	0.70	0.45			0.70	0.45					0.70	0.45	24.0
26.0						0.85	0.70	0.45		0.75	0.70	0.45			0.70	0.45					0.70	0.45	26.0
28.0						0.60	0.70	0.45			0.70	0.45				0.70	0.45				0.70	0.45	28.0
30.0							0.65	0.45			0.70	0.45				0.70	0.45						30.0
32.0																							32.0
34.0																							34.0
36.0																							36.0
38.0																							38.0
40.0																							40.0
42.0																							42.0
44.0																							44.0
46.0																							46.0
48.0																							48.0
50.0																							50.0
52.0																							52.0
54.0																							54.0
55.0																							55.0
56.0																							56.0
1	0	0	0	0	0	0	0	0	46	46	46	46	92	92	92	92	100	100	100	100	1	1	
2	0	0	0	0	92	92	92	92	92	92	92	92	92	92	92	92	100	100	100	100	2	2	
3	0	0	0	0	92	92	92	92	92	92	92	92	92	92	92	92	100	100	100	100	3	3	
4	0	0	0	0	92	92	92	92	92	92	92	92	92	92	92	92	100	100	100	100	4	4	
5	0	0	0	0	92	92	92	92	92	92	92	92	92	92	92	92	100	100	100	100	5	5	
ID	1	1	1	1	9	9	9	9	10	10	10	10	11	11	11	11	22	22	22	22	ID	ID	
[DEG]	19~84																						

作業半径一揚程図

作業半径一揚程図

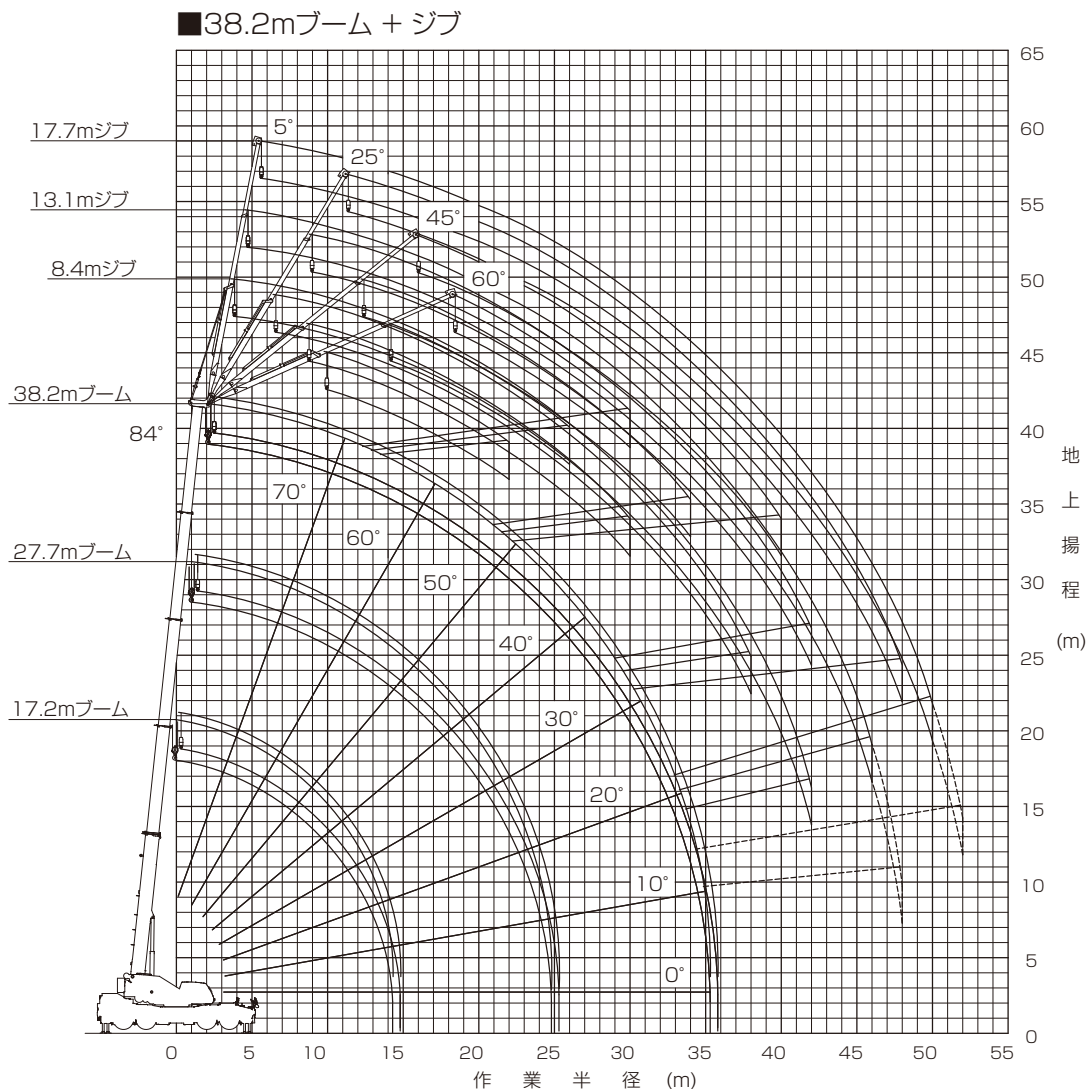
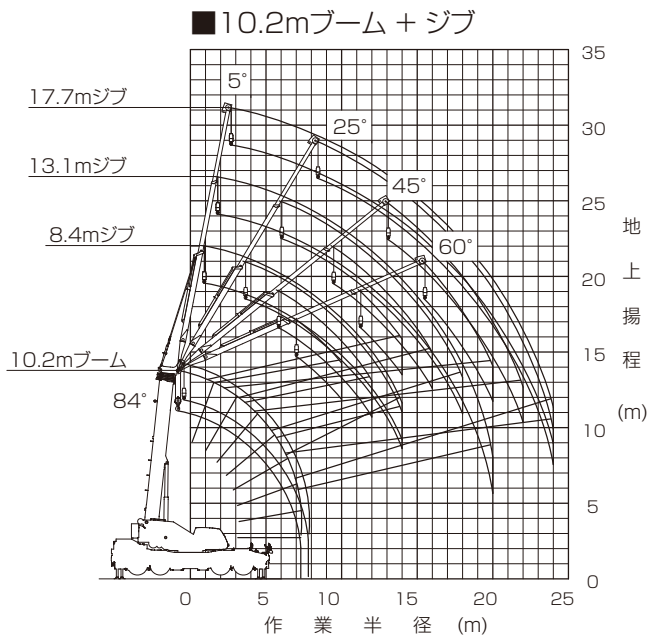

- (注) 1. 上図は、ブームおよびジブのたわみを含んでいません。
2. 上図は、アウトリガ最大 (7.8m) 張出状態、カウンタウエイト装着状態での図です。
3. 上図破線の部分は、スマートチャート1性能の場合を示しています。

作業半径一揚程図

■41.7mブーム + ジブ

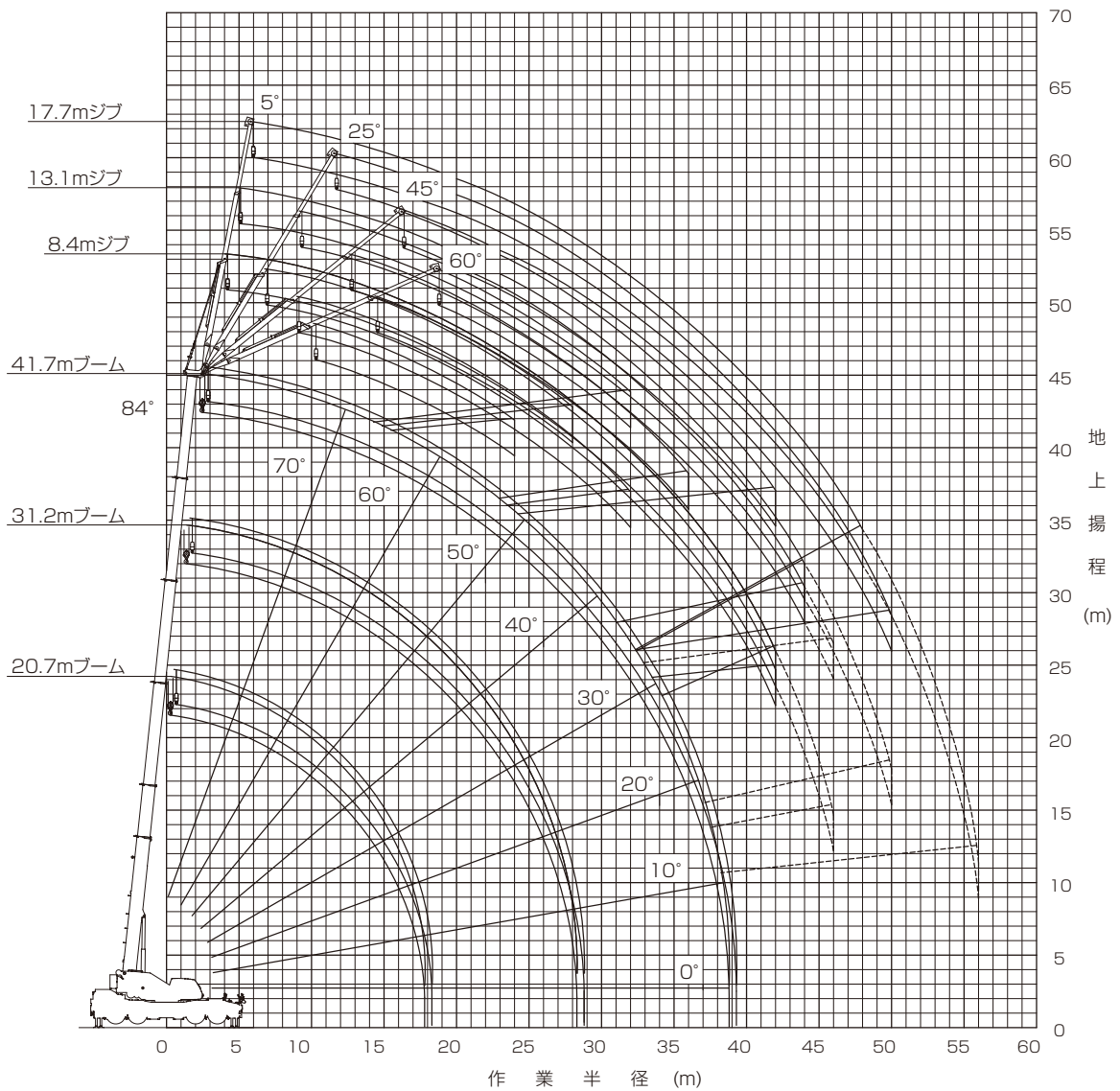

- (注) 1. 上図は、ブームおよびジブのたわみを含んでいません。
 2. 上図は、アウトリガ最大 (7.8m) 張出状態、カウンタウエイト装着状態での図です。
 3. 上図破線の部分は、スマートチャート1性能の場合を示しています。

作業半径－揚程図

作業半径－揚程図

■45.2mブーム + ジブ

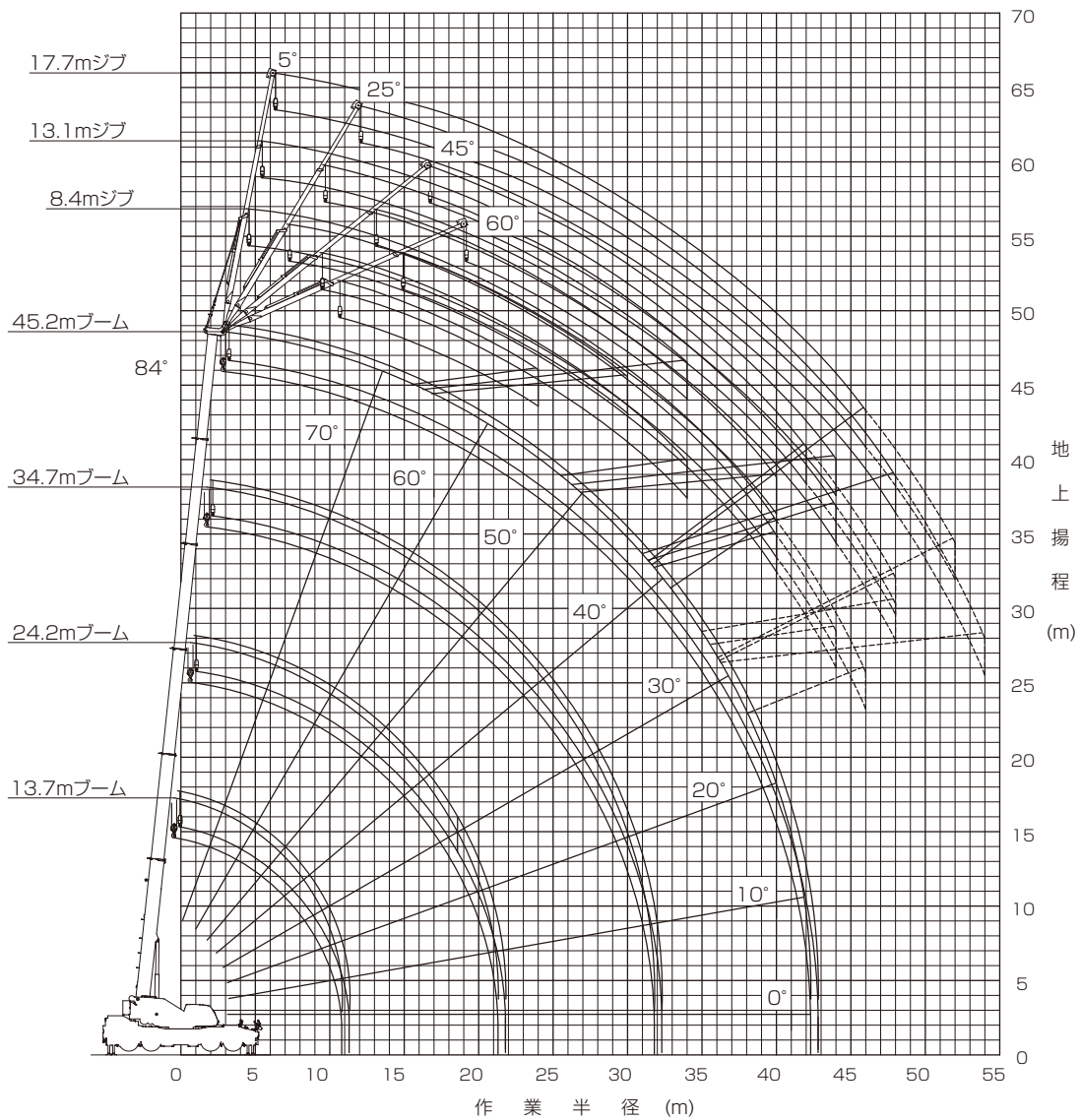

- (注) 1. 上図は、ブームおよびジブのたわみを含んでいません。
 2. 上図は、アウトリガ最大 (7.8m) 張出状態、カウンタウエイト装着状態での図です。
 3. 上図破線の部分は、スマートチャート1性能の場合を示しています。

作業半径一揚程図

■48.0mブーム + ジブ

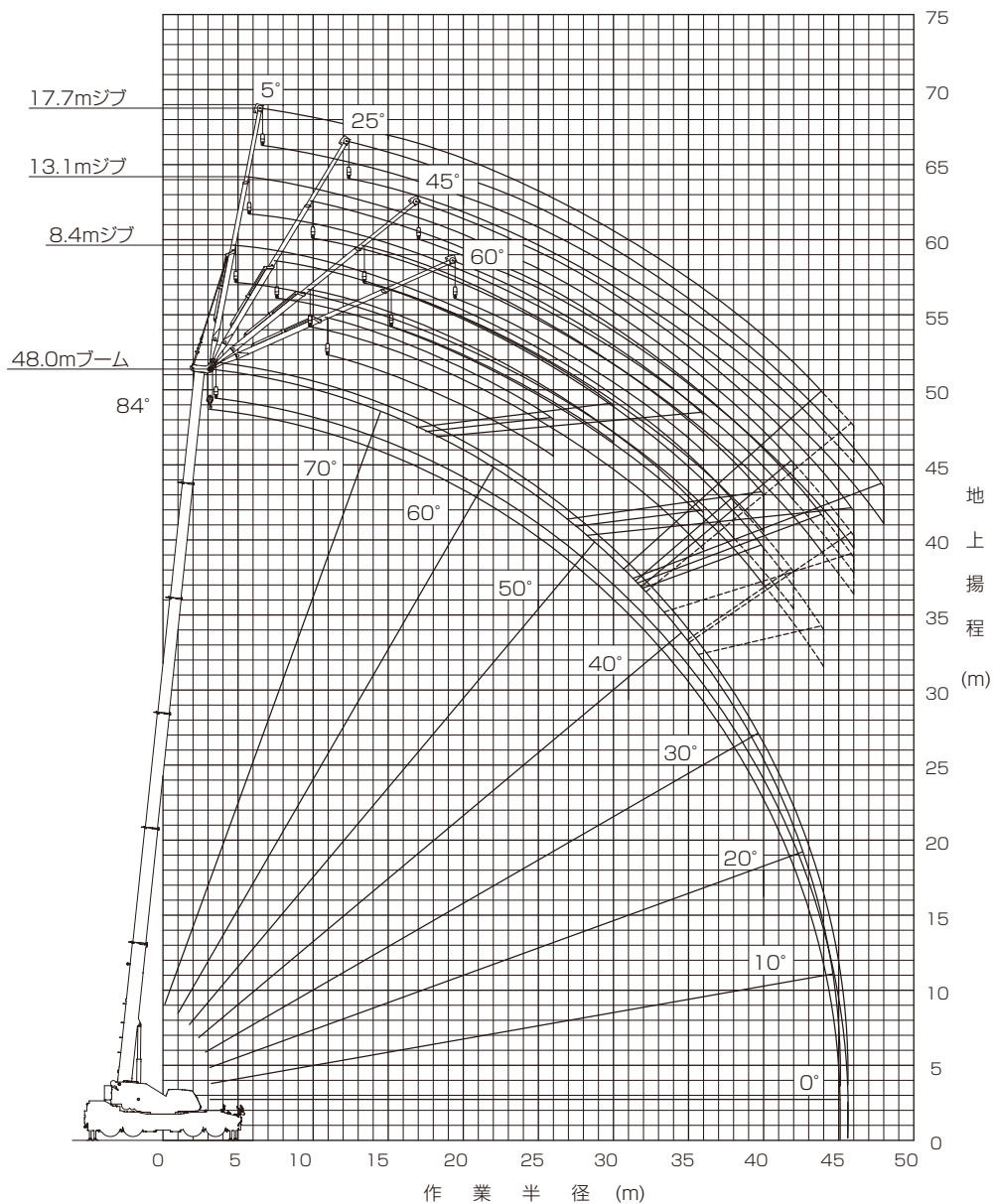

- (注) 1. 上図は、ブームおよびジブのたわみを含んでいません。
 2. 上図は、アウトリガ最大 (7.8m) 張出状態、カウンタウエイト装着状態での図です。
 3. 上図破線の部分は、スマートチャート1性能の場合を示しています。

作業領域

■ 作業領域図の見方

【標準性能】

作業領域図の円の大きさは、アウトリガ張出幅で決まる性能に対応しています。
さらにカウンタウエイトの装着状態に応じて下表のように制限しています。

C/W 質量 性能区分	適用性能 (ブーム作業)		適用性能 (ジブ作業)	
	4 t	0 t	4 t	0 t
円 1	○	○	○	○
円 2	○	○	○	○
円 3	○	○	○	○
円 4	○	○	○	○
円 5	○	○	○	○
円 6	○	○	○	○
円 7	○	○	○	○
円 8	○	○	○	○
円 9	○	○	○	○
円 10	△	○	△	△
円 11	△	○	△	△

一例

図のアウトリガ張出幅でブーム作業を行う場合、作業領域別の性能および範囲は、次のようになります。

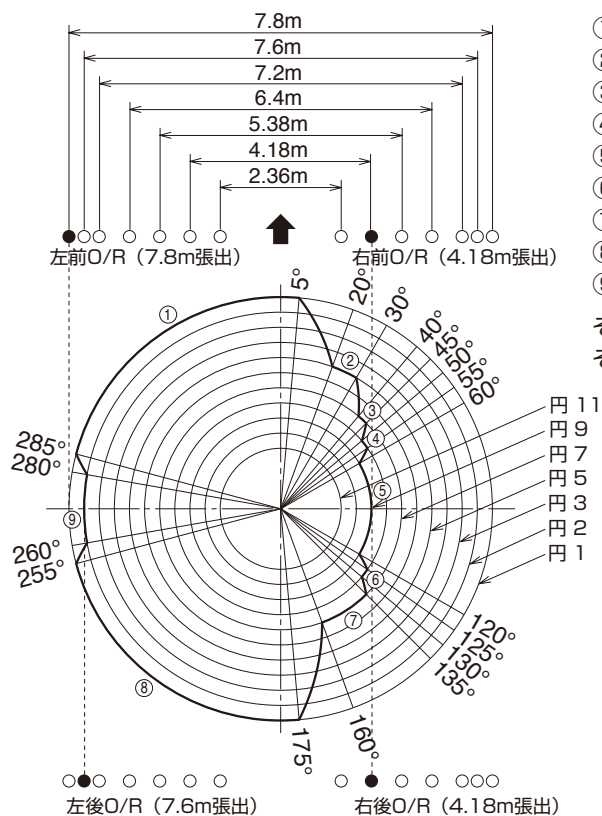

- ①の領域：最大張出（7.8m）性能
- ②の領域：中間張出（6.4m）性能
- ③の領域：中間張出（5.38m）性能
- ④の領域：アウトリガ張出幅（4.8m）で補間計算した性能
- ⑤の領域：中間張出（4.18m）性能
- ⑥の領域：アウトリガ張出幅（4.8m）で補間計算した性能
- ⑦の領域：中間張出（5.38m）性能
- ⑧の領域：最大張出（7.8m）性能
- ⑨の領域：中間張出（7.6m）性能

それぞれの性能領域を結ぶ切換領域は5°とし、
それぞれの性能で比例して増減しています。

作業領域

■ 作業領域図

【標準性能】

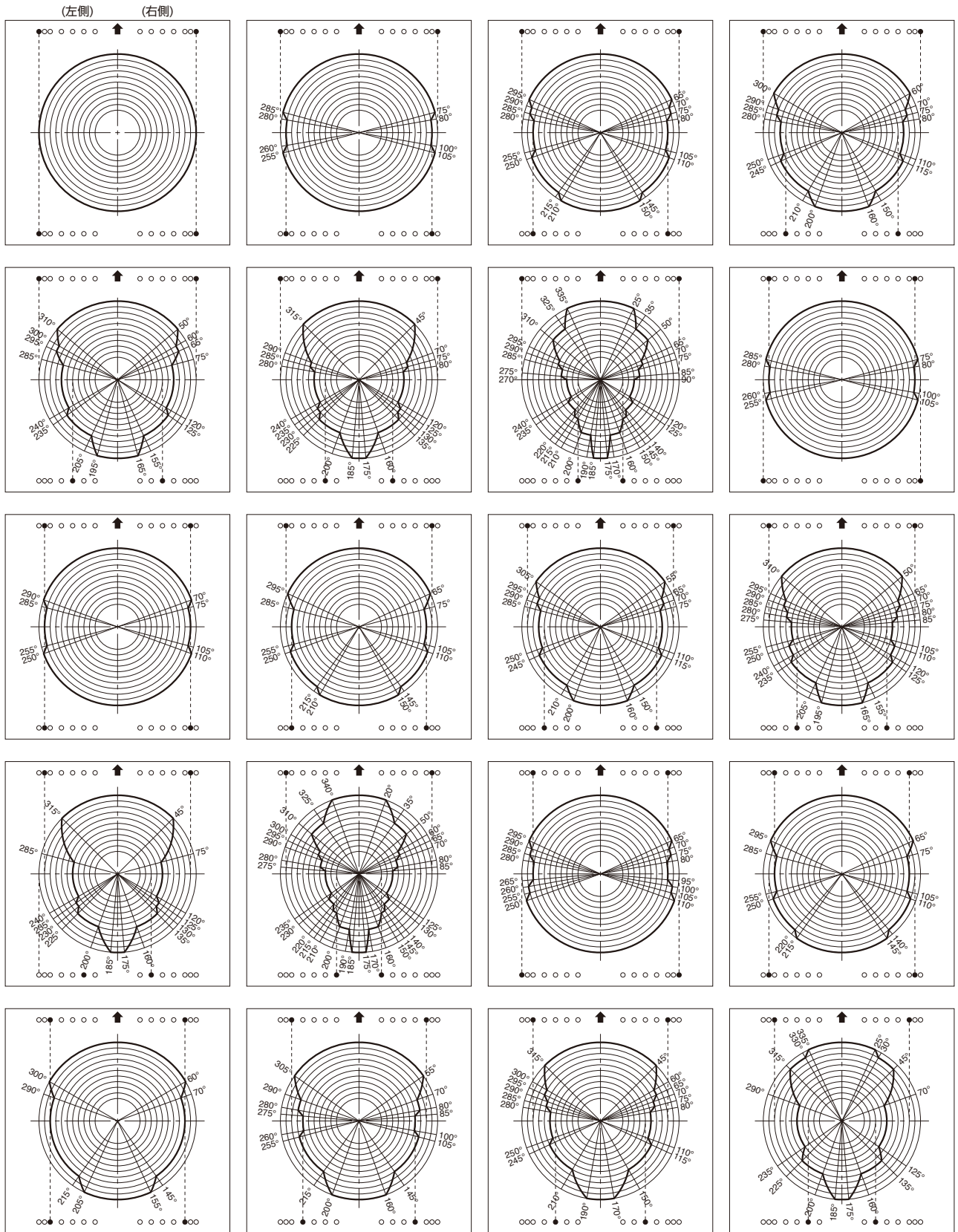

【標準性能】

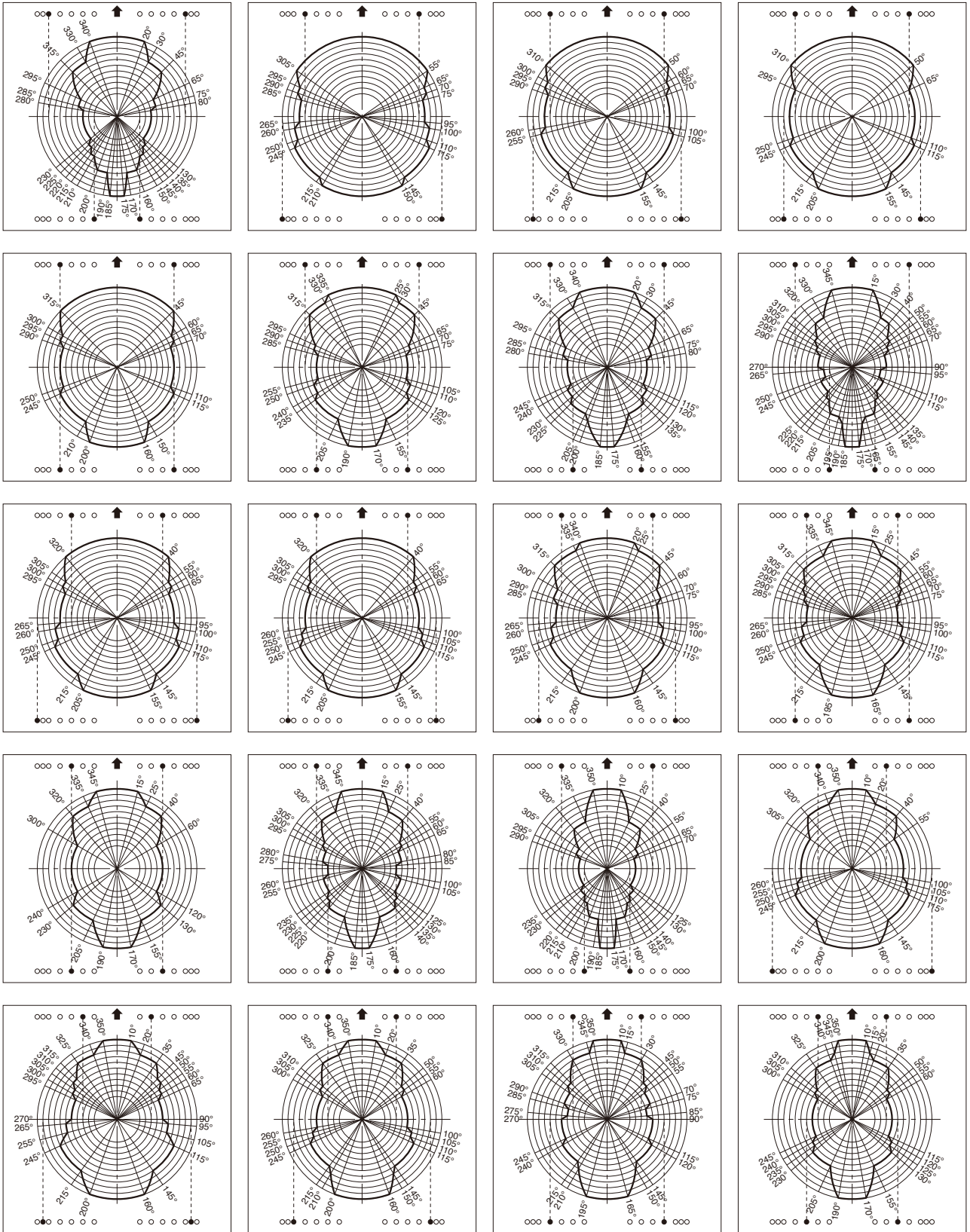

作業領域

【標準性能】

(左側) (右側)

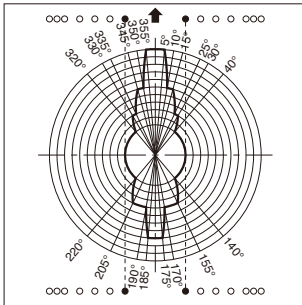
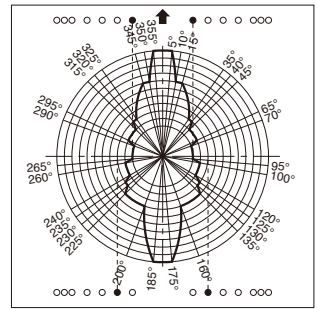
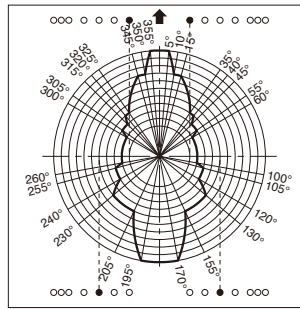
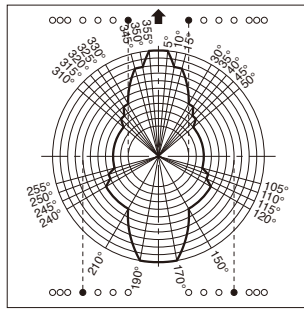
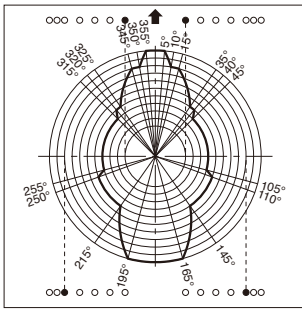
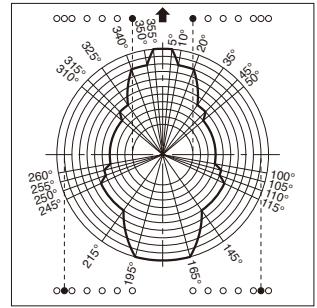
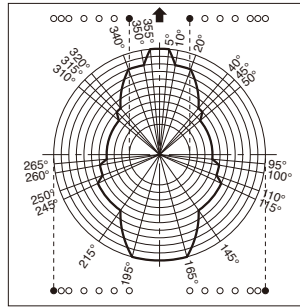
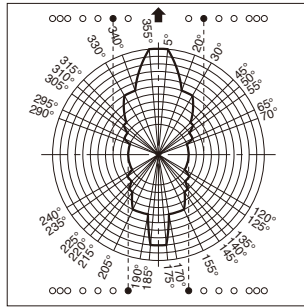
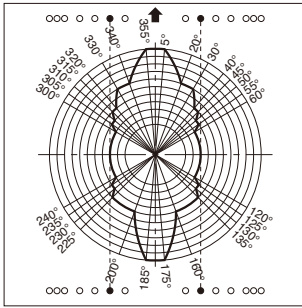

作業領域

■ 作業領域図の見方

【スマートチャート性能】

作業領域図の円の大きさは、アウトリガ張出幅で決まる性能に対応しています。
さらにカウンタウエイトの装着状態に応じて下表のように制限しています。

領域	C/W 質量 性能区分	適用性能 (ブーム作業)		適用性能 (ジブ作業)	
		4 t	0 t	4 t	0 t
領域①	スマートチャート1	○	○	○	○
領域②	スマートチャート2	○	○	○	○
円 1	7.8 m	○	○	○	○
円 2	7.6 m	○	○	○	○
円 3	7.2 m	○	○	○	○
円 4	(6.8 m)	○	○	○	○
円 5	6.4 m	○	○	○	○
円 6	(6.0 m)	○	○	○	○
円 7	5.38 m	○	○	○	○
円 8	(4.8 m)	○	○	○	○
円 9	4.18 m	○	○	○	○
円 10	(3.5 m)	/		/	
円 11	2.36 m	/		/	

一例

図のアウトリガ張出幅でブーム作業を行う場合、作業領域別の性能および範囲は、次のようになります。

スマートチャート性能は、前方の安定度で決まるスマートチャート1性能と後方の安定度で決まるスマートチャート2性能から成り立っています。また、各性能の変化部分は比例補間されます。

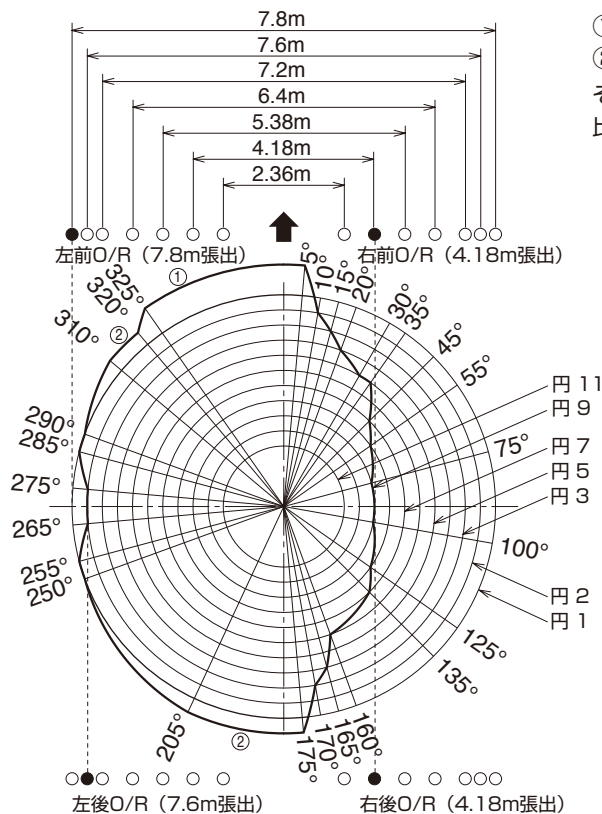

①の領域：スマートチャート1性能

②の領域：スマートチャート2性能

それぞれの性能領域を結ぶ切換領域はそれぞれの性能で比例して増減しています。

作業領域

■ 作業領域図



【スマートチャート性能】

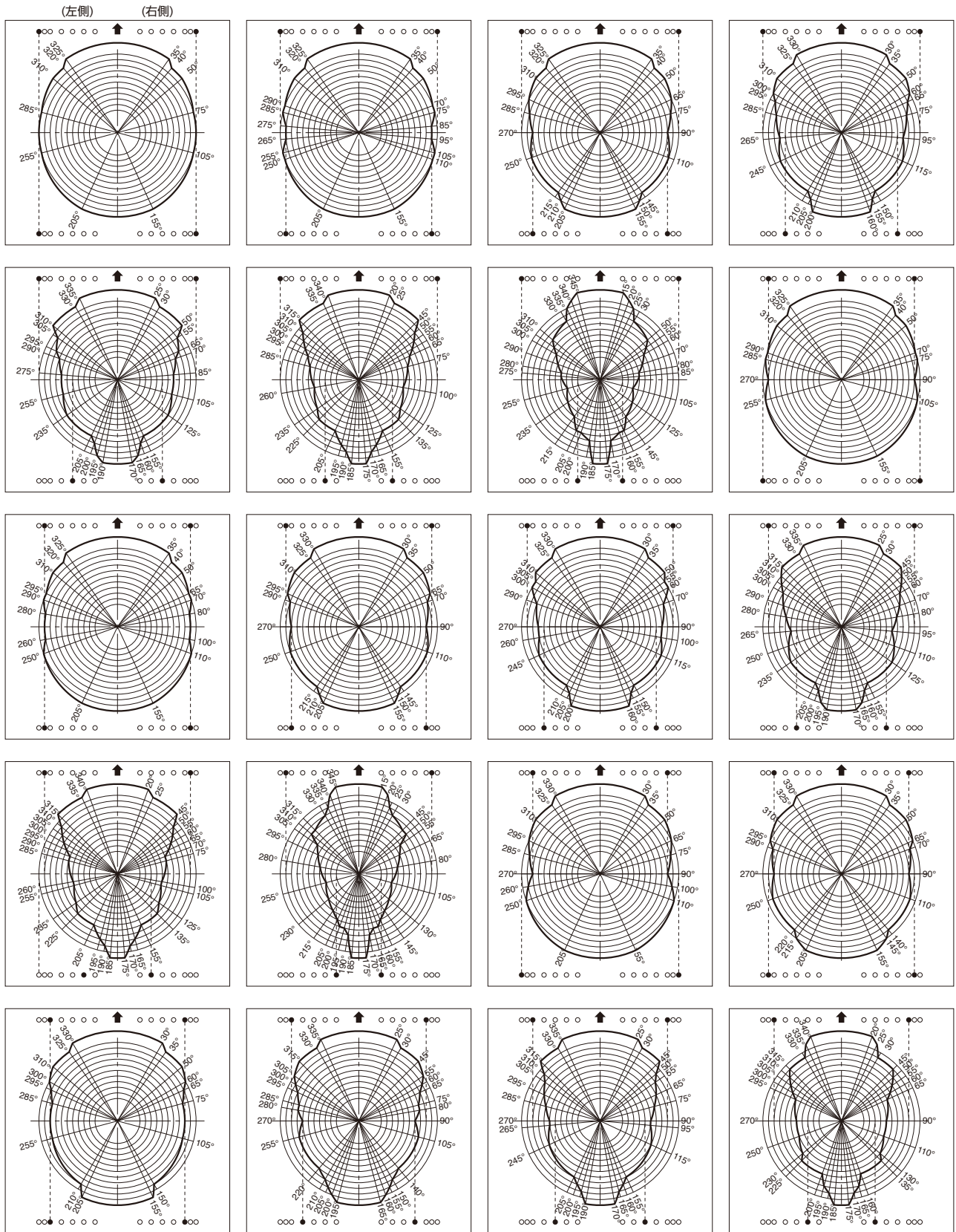



【スマートチャート性能】

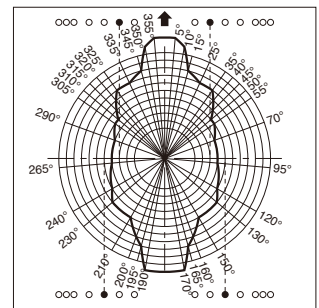
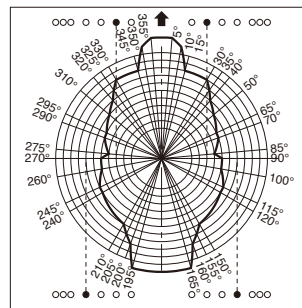
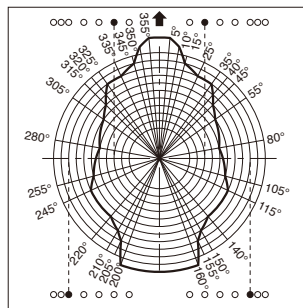
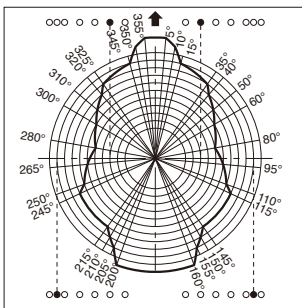
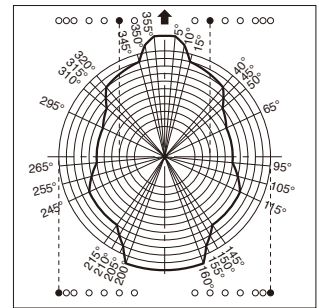
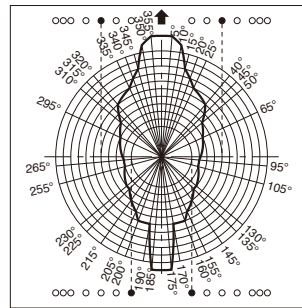
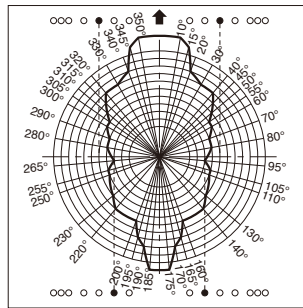
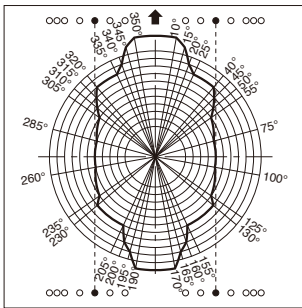
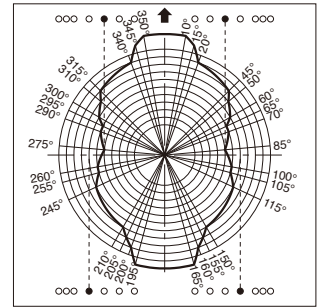
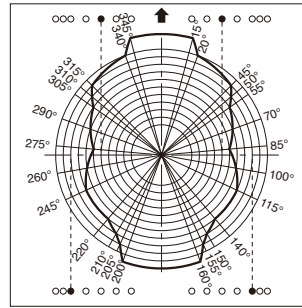
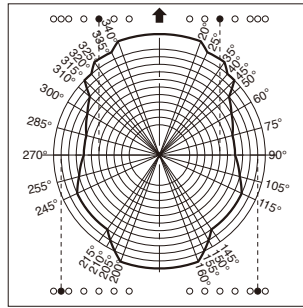
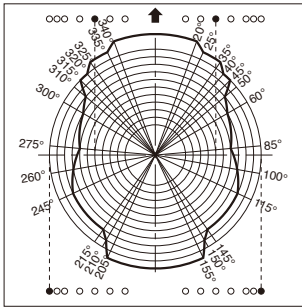
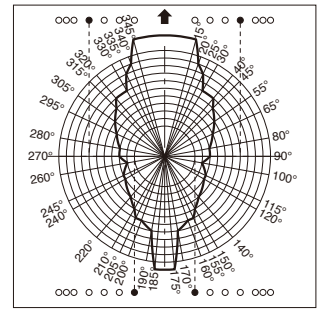
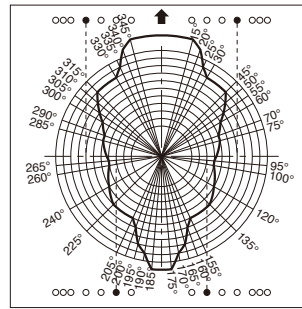
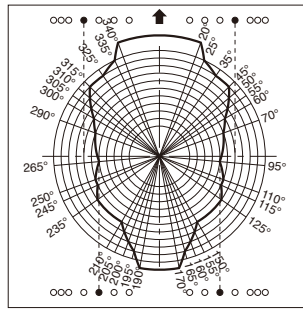
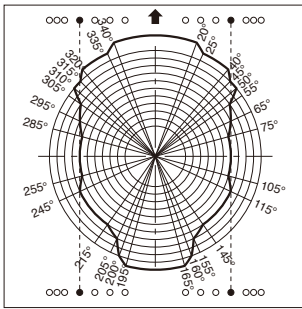
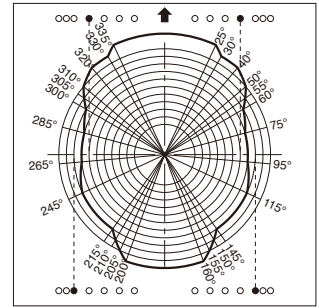
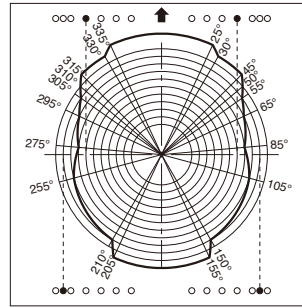
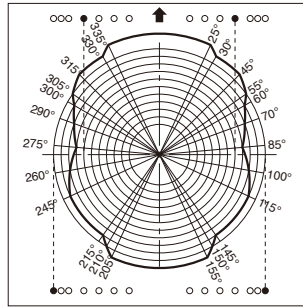
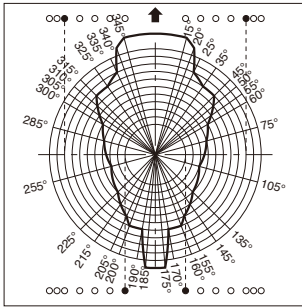

作業領域



【スマートチャート性能】

(左側) (右側)

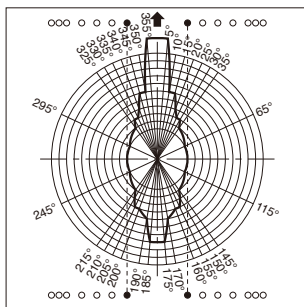
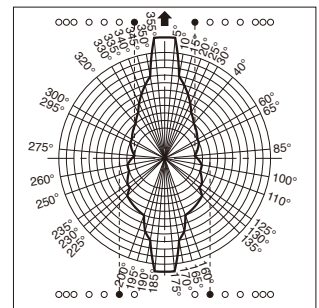
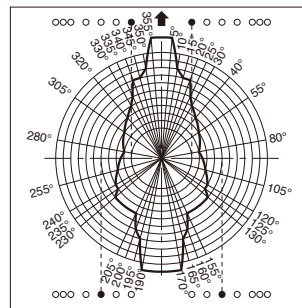
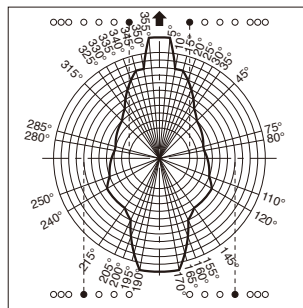
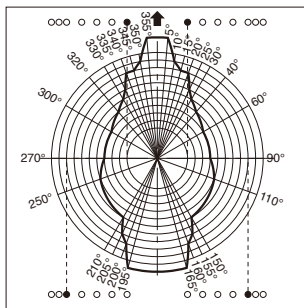
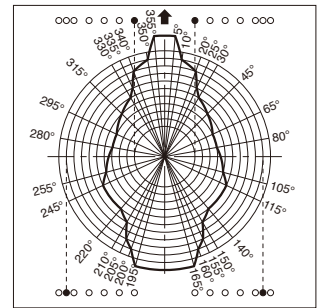
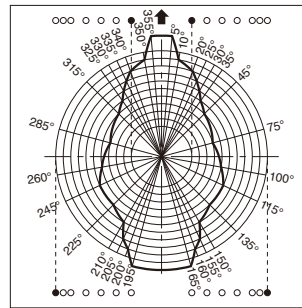
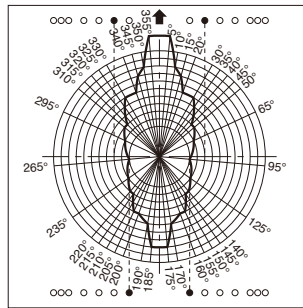
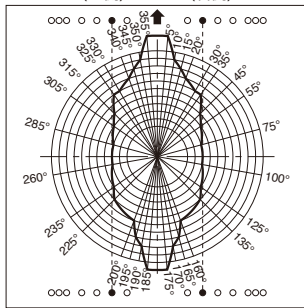



●製品は、改良などのためこの仕様と相違する場合がありますので、ご了承ください。

GR-1000N-1-00101 ブーム+フルオートジブ(FAJ)仕様

1812-01-03 ■■■