

タダノ ラフテレーンクレーン

GR-600N 型

(5 段ブーム、2 段フルオートジブ、H 型アウトリガ)

仕 様 書

スペック番号 GR-600N-3-00101

株式会社 タダノ

GR-600N (Ⅲ)

5段ブーム
2段フルオートジブ
H型アウトリガ



●主要諸元

●クレーン

クレーン 容 量	10.3mブーム	60,000kg × 1.8m (13本掛)	
	14.1mブーム	35,000kg × 4.0m (7本掛)	
	17.8mブーム	35,000kg × 3.5m (7本掛)	
	25.4mブーム	20,300kg × 5.5m (5本掛)	
	33.6mブーム	14,000kg × 6.5m (4本掛)	
	37.3mブーム	11,000kg × 8.0m (4本掛)	
	40.0mブーム	7,600kg × 12.0m (4本掛)	
	41.2mブーム	7,200kg × 11.0m (4本掛)	
	8.5mジブ	3,800kg × 16.0m (1本掛)	
	13.7mジブ	2,500kg × 20.0m (1本掛)	
	シングルトップ	5,000kg (1本掛)	
	最大地上揚程	ブーム	42.6m
		ジブ	55.8m
最大作業半径	ブーム	36.0m(標準性能)、38.0m(スマートチャート性能)	
	ジブ	40.0m(標準性能)、42.0m(スマートチャート性能)	
ブーム長さ	10.3m~41.2m		
ブーム伸縮長さ	30.9m		
ブーム伸長速度	30.9m/127s		
ジブ長さ	8.5m~13.7m		
巻き上げ速度 (ロースピード)	主巻	127m/min(5層)	
	補巻	112m/min(3層)	
フック 巻き上げ速度	主巻	18.1m/min(7本掛)	
	補巻	112m/min(1本掛)	
巻き下げ速度 (ロースピード) [参考]	主巻	標準:127m/min(5層)、高速:195m/min(5層)	
	補巻	標準:106m/min(3層)、高速:163m/min(3層)	
ブーム起伏角度	0°~83.5°		
ブーム上げ速度	0°~83.5°/48s		
旋回角度	360°連続		
旋回速度	2.2min ⁻¹ {rpm}		
ワイヤロープ	主巻	径16mm×長さ230m 非自転性ワイヤロープ	
	補巻	径16mm×長さ120m 非自転性ワイヤロープ	
ブーム形式	ラウンド形5段油圧伸縮式(2段目順次、3・4・5段目同時)		
ブーム伸縮装置	複動油圧シリンダ直押し2本、ワイヤロープ式伸縮装置2基		
ジブ形式	クイックターン式(ブーム下抱込側面格納式) 2段(2段油圧伸縮式)、オフセット5°~6°油圧無段階傾斜式		
シングルトップ形式	先端ブーム固定式		
巻き上げ装置	油圧モータ駆動遊星歯車減速式、自動ブレーキ、高速巻き下げ機能、シングルウインチ2基、圧力補償付流量調整弁付		
ブーム起伏装置	複動油圧シリンダ直押し1本、圧力補償付流量調整弁付		
旋回装置	油圧モータ駆動遊星歯車減速式、ボールベアリング式、旋回フリーロック切換式、ネガティブブレーキ		
アウトリガ	全油圧式H型(フロート一体型)、スライドジャッキ各個操作装置付 張出幅最大7.6m、中間7.2m、6.5m、5.28m、4.28m、最小2.36m		
操作方式	電気操作式		
作業時最大路面荷重	35.8t		
動力取出方式	PTO湿式多板クラッチ式		
油圧ポンプ	2連可変ピストンポンプ、2連ギヤポンプ		
安全装置	過負荷防止装置(AML)、旋回自動停止装置、起伏緩停止装置、 巻過防止装置、作業領域制御装置、アウトリガ張出幅検出装置、 伸縮シリンダ油圧ロック装置、起伏シリンダ油圧ロック装置、 パワーチルトシリンダ油圧ロック装置、水準器、油圧安全弁、 ジャッキシリンダ油圧ロック装置、旋回ロック装置、 ジブ伸縮シリンダ油圧ロック装置、玉掛けロープはずれ止め		
	除湿機能付フルオートエアコン、作動油温度計、拡声器、 FM・AMラジオ、オイルクーラー、視覚式ドラムインジケータ、 ドラム回転音装置、旋回作動音装置		
付属装置	操作ペダル…ISO配列の場合:伸縮用および補巻用 タダノ配列の場合:起伏用および伸縮用 作業準備用ラジオ、テレマティクス、無線LAN通信端末、 燃料消費モニター、エコモード、作動油目づまり警報装置		
付属品	盤木(4枚)、アルミ敷板(4枚)		

●キャリヤ

車名および型式	タダノ YDS-T016	
エンジン	名称	カミンズ QSL9-4B (過給機、給気冷却器および尿素SCRシステム付)
	形式	水冷4サイクル6気筒直噴射式ディーゼルエンジン
	総排気量	8.849L
	最高出力	283kW{385PS}/1,900min ⁻¹ {rpm}
	最大トルク	1,627N·m{166kgf·m}/1,500min ⁻¹ {rpm}
トルクコンバータ形式	3要素1段(自動ロックアップ機構付)	
変速機形式	自動及び手動変速式、パワーシフト式(湿式多板クラッチ) 前進4段、後退1段(Hi,Lo付)	
減速機形式	車軸2段減速式(2、3軸)	
駆動方式	4WD(6×4)	
車軸方式(全軸)	全浮動式	
懸架方式(全軸)	ハイドロニューマチックサスペンション(油圧ロックシリンダ付)	
ステアリング形式	全油圧式パワーステアリング	
ブレーキ	主ブレーキ	空気油圧複合式ディスクブレーキ
	駐車ブレーキ	空気式推進軸制動内部拡張式(3軸)
	補助ブレーキ	永久磁石式リターダ、エンジンリターダ、 作業用補助制動装置
フレーム	箱型溶接構造	
バッテリー	12V~120Ah×2個(24V)	
燃料タンク容量	400L	
尿素水タンク容量	38L	
タイヤ	前輪	385/95 R25 170E ROAD
	後輪	385/95 R25 170E ROAD
運転室	乗車定員1人、内装付、 液体封入ゴムマウント方式(ビスカス)、 フルアジャスタブルシート (ヘッドレスト、アームレスト、シートベルト付)、 アジャスト式ハンドル(チルト、伸縮)、 間欠式フロント天井ワイパー(ウォッシャー付)、 パワーウィンドー、サイドバイザー	
安全装置	緊急及び取装置、サスペンションロック装置、 リヤステアリングロック装置、 エンジンオーバーラン警報装置、 オーバシフト防止装置、駐車ブレーキ警報装置、 ブーム左右サイドカメラ、ラジエータ液面警報装置、 作動油漏れ警報装置	
付属装置	ヒータ付電動格納ミラー、俯瞰映像表示装置、 盗難防止装置、タイヤ歯止め、LEDヘッドランプ、 人物検知警報装置	

●オプション

ウインチドラム監視カメラ、リモコンサーチライト、AML外部表示灯、路肩灯、
マーカーランプ、LEDマーカーランプ、外部音声警報装置、集中給油装置、
ハロゲンヘッドランプ、作業用後方監視カメラ、風速計、LED作業灯

●走行時寸法

全長	12,895mm
全幅	2,780mm
全高	3,720mm
軸距	1,850mm +
	4,450mm
輪距	前輪 2,330mm
	後輪 2,330mm

●走行性能

最高速度	49km/h
登坂能力(tanθ)	0.46
最小回転半径	6.7m (6輪ステアリング)
	11.0m (前4輪ステアリング)

●重量

車両総重量	36,195kg
前前軸重	11,705kg
前後軸重	10,745kg
後軸重	13,745kg

●最大ジャッキ反力(作業時最大路面荷重)

ブーム	35.8t
ジブ	27.4t

■ 定格総荷重表注意事項 【アウトリガ使用時】

1. 定格総荷重は、水平堅土上においてクレーンを水平に設置した状態での値で、ブーム作業時はつり具と主巻フック質量(35tフック:310kg)を、ジブ作業時はつり具と補巻フック質量(100kg)を含んだ値です。太線より上はクレーンの強度によって定められ、下はクレーンの安定度によって定められています。
2. 作業半径は、ブームのたわみを含んだ実際の値に基づいていますので、ブーム作業時は必ず作業半径を基準にしてください。
3. シングルトップ使用時のワイヤロープ巻掛本数は1本です。
シングルトップの定格総荷重は、ブームの定格総荷重から210kgを差し引いた値とし、つり具と補巻フック質量(100kg)を含んだ値で、かつ限度は5.0tです。
4. 高速巻き下げは、フックのみを降下するときに使用してください。また、急激なレバー操作は避けてください。
5. 各ブーム長さにおける標準フックとワイヤロープ標準巻掛本数はブームの各定格総荷重表中に記載しています。
ただし、この掛数以外で使用する場合は、ロープ1本当たり主巻5.0t以下、補巻5.0t以下としてください。
6. ジブ使用時のフックのワイヤロープ巻掛本数は1本です。
7. 側方域でのつり上げ性能は、アウトリガ張出幅によって異なります。張出幅に応じた性能で作業をしてください。
また、前方・後方域でのつり上げ性能は「アウトリガ張出幅7.6m」の定格総荷重ですが、フロントアウトリガ張出幅とリアアウトリガ張出幅の組み合わせによってその前方・後方域の範囲(角度a、b)が異なります。

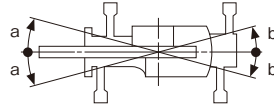

		前方域						
		フロントアウトリガ張出状態						
角度 a°		最大張出	中間張出				最小張出	
		7.6m	7.2m	6.5m	5.28m	4.28m	2.36m	
リアアウトリガ張出状態	最大張出	7.6m	90	35	25	15	10	5
	中間張出	7.2m	70	30	25	15	10	5
		6.5m	35	30	20	15	10	5
		5.28m	30	25	20	10	5	5
		4.28m	25	20	15	10	5	5
	最小張出	2.36m	20	15	15	10	5	-

		後方域						
		フロントアウトリガ張出状態						
角度 b°		最大張出	中間張出				最小張出	
		7.6m	7.2m	6.5m	5.28m	4.28m	2.36m	
リアアウトリガ張出状態	最大張出	7.6m	90	70	35	30	25	20
	中間張出	7.2m	70	30	30	25	20	20
		6.5m	25	25	20	20	15	15
		5.28m	15	15	15	10	10	10
		4.28m	10	10	10	5	5	5
	最小張出	2.36m	5	5	5	5	5	-

8. スマートチャート性能は、フロントアウトリガ張出幅とリアアウトリガ張出幅の組み合わせによって、作業が行える前方・後方の範囲(角度c、d)が異なります。また側方域でのつり上げ性能は、アウトリガ張出幅に応じた標準性能となります。

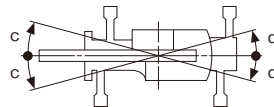

		前方域						
		フロントアウトリガ張出状態						
角度 c°		最大張出	中間張出				最小張出	
		7.6m	7.2m	6.5m	5.28m	4.28m	2.36m	
リアアウトリガ張出状態	最大張出	7.6m	45	30	20	15	10	5
	中間張出	7.2m	45	25	20	10	10	5
		6.5m	30	25	20	10	5	5
		5.28m	25	20	15	10	5	5
		4.28m	20	20	15	10	5	5
	最小張出	2.36m	15	15	10	5	5	-

		後方域						
		フロントアウトリガ張出状態						
角度 d°		最大張出	中間張出				最小張出	
		7.6m	7.2m	6.5m	5.28m	4.28m	2.36m	
リアアウトリガ張出状態	最大張出	7.6m	25	25	25	25	20	20
	中間張出	7.2m	25	25	25	20	20	15
		6.5m	20	20	20	15	15	10
		5.28m	15	10	10	10	10	5
		4.28m	10	10	5	5	5	5
	最小張出	2.36m	5	5	5	5	5	-

定格総荷重表中のシンボル、記号の説明

	MB	ブームの定格総荷重を示します。		m	作業半径を示します。
	FAJ	フルオートジブ (FAJ) の定格総荷重を示します。		%	ブーム伸縮状態 (伸縮割合 %) を示します。 MODEはブーム伸縮モードを示します。
		アウトリガ張出幅を示します。			無負荷状態で作動可能なブーム起伏角度範囲を示します。
	360°	吊上げ可能な旋回範囲を示します。			フルオートジブ (FAJ) のジブ長さを示します。
	SMART CHART スマートチャート	スマートチャートの場合、スマートチャート性能で作業可能であることを示します。			フルオートジブ (FAJ) のオフセット角度を示し、ブームの中心線とジブの中心線のなす角度を示します。
	t JPN	定格総荷重の単位を示します。			標準巻掛本数を示します。
	m	ブーム長さを示します。			標準フックを示します。

■ブーム伸縮モード

ブーム伸縮モードには「伸縮モード1」(2段目ブーム先伸長方式)と「伸縮モード2」(3段目・4段目・トップブーム先伸長方式)の2種類があります。

「伸縮モード1」は強度域性能、「伸縮モード2」は安定域性能を重視します。

各伸縮モードにおけるブーム長さ・伸縮割合は下図に示すとおりです。ブーム全縮時、全伸長時以外のときは、ブーム伸縮モードの選択はできません。

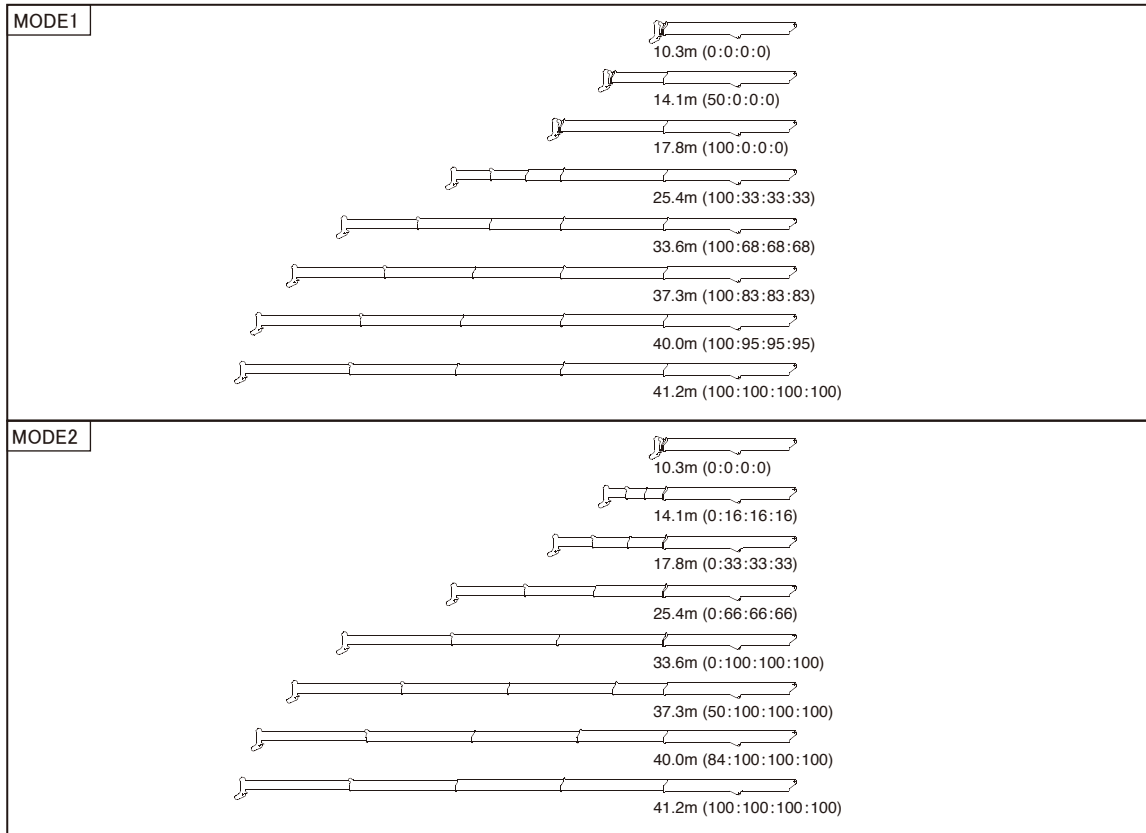

■ブーム定格総荷重表



m	10.3	14.1	14.1	17.8	17.8	25.4	25.4	33.6	33.6	37.3	37.3	40.0	40.0	41.2	m
1.8	※60.00	35.00	20.30	35.00	20.30	20.30	16.80								1.8
2.1	※57.00	35.00	20.30	35.00	20.30	20.30	16.80								2.1
2.5	※55.00	35.00	20.30	35.00	20.30	20.30	16.80	14.00	12.00						2.5
3.0	50.00	35.00	20.30	35.00	20.30	20.30	16.80	14.00	12.00	11.00	10.00				3.0
3.5	42.00	35.00	20.30	35.00	20.30	20.30	16.80	14.00	12.00	11.00	10.00	7.60	7.60	7.20	3.5
4.0	39.20	35.00	20.30	34.50	20.30	20.30	16.80	14.00	12.00	11.00	10.00	7.60	7.60	7.20	4.0
4.5	36.60	34.70	20.30	32.50	20.30	20.30	16.80	14.00	12.00	11.00	10.00	7.60	7.60	7.20	4.5
5.0	34.10	32.60	20.30	30.70	20.30	20.30	16.80	14.00	11.40	11.00	10.00	7.60	7.60	7.20	5.0
5.5	30.70	30.40	20.30	29.00	20.30	20.30	16.80	14.00	10.80	11.00	10.00	7.60	7.60	7.20	5.5
6.0	27.70	27.50	20.30	27.20	20.30	19.90	16.60	14.00	10.30	11.00	10.00	7.60	7.60	7.20	6.0
6.5	25.20	24.90	20.30	24.70	20.30	19.00	15.80	14.00	9.80	11.00	10.00	7.60	7.60	7.20	6.5
7.0	23.10	22.80	20.30	22.60	20.30	18.20	15.00	13.80	9.40	11.00	9.80	7.60	7.60	7.20	7.0
8.0		19.20	20.30	19.00	20.30	16.80	13.70	12.90	8.60	11.00	9.00	7.60	7.60	7.20	8.0
9.0		15.80	17.10	15.60	17.50	15.40	12.50	12.00	7.90	10.80	8.30	7.60	7.60	7.20	9.0
10.0		13.30	14.50	13.10	14.90	14.10	11.50	11.20	7.30	10.10	7.70	7.60	7.60	7.20	10.0
11.0		11.30	12.50	11.10	12.90	12.10	10.70	10.50	6.70	9.50	7.20	7.60	7.40	7.20	11.0
12.0				9.60	11.30	10.50	10.00	9.70	6.30	9.00	6.70	7.60	7.00	7.10	12.0
14.0				7.20	8.90	8.20	8.70	8.40	5.50	7.80	5.90	7.40	6.20	6.30	14.0
16.0						6.30	7.60	6.90	4.90	6.80	5.30	6.50	5.50	5.60	16.0
18.0						4.80	6.10	5.40	4.40	5.50	4.80	5.60	5.00	5.10	18.0
20.0						3.70	5.00	4.20	4.00	4.40	4.30	4.50	4.50	4.50	20.0
22.0						2.80	4.10	3.30	3.50	3.50	3.90	3.60	3.70	3.60	22.0
24.0								2.60	3.20	2.80	3.20	2.90	3.00	2.90	24.0
26.0								2.10	2.90	2.20	2.60	2.30	2.40	2.30	26.0
28.0								1.60	2.50	1.70	2.10	1.80	1.90	1.90	28.0
30.0								1.30	2.10	1.40	1.70	1.40	1.50	1.50	30.0
32.0										1.10	1.40	1.10	1.20	1.10	32.0
34.0										0.85	1.20	0.85	1.00	0.90	34.0
36.0											0.65	0.75	0.65	0.65	36.0
38.0												0.50	0.50	0.50	38.0
1	0	50	0	100	0	100	0	100	0	100	50	100	84	100	1
2	0	0	16	0	33	33	66	68	100	83	100	95	100	100	2
3	0	0	16	0	33	33	66	68	100	83	100	95	100	100	3
4	0	0	16	0	33	33	66	68	100	83	100	95	100	100	4
MODE	1,2	1	2	1	2	1	2	1	2	1	2	1	2	1,2	MODE
[DEG]	0~83.5														[DEG]
※13/10	7	5	7	5	5	4	4	4	4	4	4	4	4	4	
重荷重装置	35t														



m	10.3	14.1	14.1	17.8	17.8	25.4	25.4	33.6	33.6	37.3	37.3	40.0	40.0	41.2	m	
1.8	※60.00	35.00	20.30	35.00	20.30	20.30	16.80								1.8	
2.1	※57.00	35.00	20.30	35.00	20.30	20.30	16.80								2.1	
2.5	※55.00	35.00	20.30	35.00	20.30	20.30	16.80	14.00	12.00						2.5	
3.0	50.00	35.00	20.30	35.00	20.30	20.30	16.80	14.00	12.00	11.00	10.00				3.0	
3.5	42.00	35.00	20.30	35.00	20.30	20.30	16.80	14.00	12.00	11.00	10.00	7.60	7.60	7.20	3.5	
4.0	39.20	35.00	20.30	34.50	20.30	20.30	16.80	14.00	12.00	11.00	10.00	7.60	7.60	7.20	4.0	
4.5	36.60	34.70	20.30	32.50	20.30	20.30	16.80	14.00	12.00	11.00	10.00	7.60	7.60	7.20	4.5	
5.0	34.10	32.60	20.30	30.70	20.30	20.30	16.80	14.00	11.40	11.00	10.00	7.60	7.60	7.20	5.0	
5.5	30.70	30.40	20.30	29.00	20.30	20.30	16.80	14.00	10.80	11.00	10.00	7.60	7.60	7.20	5.5	
6.0	27.70	27.50	20.30	27.20	20.30	19.90	16.60	14.00	10.30	11.00	10.00	7.60	7.60	7.20	6.0	
6.5	25.20	24.90	20.30	24.70	20.30	19.00	15.80	14.00	9.80	11.00	10.00	7.60	7.60	7.20	6.5	
7.0	23.10	22.80	20.30	22.60	20.30	18.20	15.00	13.80	9.40	11.00	9.80	7.60	7.60	7.20	7.0	
8.0		19.20	20.30	19.00	20.30	16.80	13.70	12.90	8.60	11.00	9.00	7.60	7.60	7.20	8.0	
9.0		15.70	17.10	15.40	17.50	15.40	12.50	12.00	7.90	10.80	8.30	7.60	7.60	7.20	9.0	
10.0		12.50	14.00	12.20	14.50	13.50	11.50	11.20	7.30	10.10	7.70	7.60	7.60	7.20	10.0	
11.0		10.20	11.60	9.90	12.10	11.10	10.70	10.50	6.70	9.50	7.20	7.60	7.40	7.20	11.0	
12.0				8.20	10.20	9.30	10.00	9.70	6.30	9.00	6.70	7.60	7.00	7.10	12.0	
14.0				5.80	7.70	6.80	8.10	7.40	5.50	7.60	5.90	7.40	6.20	6.30	14.0	
16.0						5.10	6.40	5.70	4.90	5.80	5.30	5.90	5.50	5.60	16.0	
18.0						3.90	5.10	4.40	4.40	4.60	4.80	4.60	4.80	4.70	18.0	
20.0						3.00	4.20	3.50	4.00	3.60	4.00	3.70	3.80	3.70	20.0	
22.0						2.30	3.40	2.80	3.50	2.90	3.30	3.00	3.10	3.00	22.0	
24.0								2.20	3.00	2.30	2.70	2.40	2.50	2.40	24.0	
26.0								1.70	2.50	1.80	2.20	1.90	2.00	1.90	26.0	
28.0								1.30	2.10	1.40	1.80	1.50	1.60	1.50	28.0	
30.0								0.95	1.80	1.00	1.40	1.10	1.20	1.10	30.0	
32.0										0.75	1.10	0.85	0.95	0.85	32.0	
34.0										0.55	0.90	0.55	0.70	0.60	34.0	
36.0													0.50		36.0	
38.0															38.0	
1	0	50	0	100	0	100	0	100	0	100	50	100	84	100	1	
2	0	0	16	0	33	33	66	68	100	83	100	95	100	100	2	
3	0	0	16	0	33	33	66	68	100	83	100	95	100	100	3	
4	0	0	16	0	33	33	66	68	100	83	100	95	100	100	4	
MODE	1.2	1	2	1	2	1	2	1	2	1	2	1	2	1.2	MODE	
[DEG]	0~83.5												18~83.5	4~83.5	25~83.5	[DEG]
※13/10	7	5	7	5	5	4	4	4	4	4	4	4	4	4		
重荷重装置	35t															



m	10.3	14.1	14.1	17.8	17.8	25.4	25.4	33.6	33.6	37.3	37.3	40.0	40.0	41.2	m			
1.8	※55.40	35.00	20.30	35.00	20.30	20.30	16.80								1.8			
2.1	※52.50	35.00	20.30	35.00	20.30	20.30	16.80								2.1			
2.5	49.00	35.00	20.30	35.00	20.30	20.30	16.80	14.00	12.00						2.5			
3.0	45.30	35.00	20.30	35.00	20.30	20.30	16.80	14.00	12.00	11.00	10.00				3.0			
3.5	42.00	35.00	20.30	35.00	20.30	20.30	16.80	14.00	12.00	11.00	10.00	7.60	7.60	7.20	3.5			
4.0	39.20	35.00	20.30	34.50	20.30	20.30	16.80	14.00	12.00	11.00	10.00	7.60	7.60	7.20	4.0			
4.5	36.60	34.70	20.30	32.50	20.30	20.30	16.80	14.00	12.00	11.00	10.00	7.60	7.60	7.20	4.5			
5.0	33.50	32.60	20.30	30.70	20.30	20.30	16.80	14.00	11.40	11.00	10.00	7.60	7.60	7.20	5.0			
5.5	30.70	30.40	20.30	29.00	20.30	20.30	16.80	14.00	10.80	11.00	10.00	7.60	7.60	7.20	5.5			
6.0	27.70	27.50	20.30	27.20	20.30	19.90	16.60	14.00	10.30	11.00	10.00	7.60	7.60	7.20	6.0			
6.5	25.20	24.90	20.30	24.70	20.30	19.00	15.80	14.00	9.80	11.00	10.00	7.60	7.60	7.20	6.5			
7.0	23.10	22.80	20.30	22.60	20.30	18.20	15.00	13.80	9.40	11.00	9.80	7.60	7.60	7.20	7.0			
8.0		18.20	19.90	17.80	20.30	16.80	13.70	12.90	8.60	11.00	9.00	7.60	7.60	7.20	8.0			
9.0		14.00	15.60	13.80	16.20	15.00	12.50	12.00	7.90	10.80	8.30	7.60	7.60	7.20	9.0			
10.0		11.20	12.60	10.90	13.20	12.20	11.50	11.20	7.30	10.10	7.70	7.60	7.60	7.20	10.0			
11.0		9.20	10.50	8.90	11.00	10.10	10.70	10.50	6.70	9.50	7.20	7.60	7.40	7.20	11.0			
12.0				7.30	9.30	8.50	9.80	9.10	6.30	9.00	6.70	7.60	7.00	7.10	12.0			
14.0				5.10	7.00	6.10	7.40	6.70	5.50	6.90	5.90	7.00	6.20	6.30	14.0			
16.0						4.60	5.80	5.10	4.90	5.30	5.30	5.40	5.50	5.40	16.0			
18.0						3.50	4.60	4.00	4.40	4.10	4.50	4.20	4.30	4.20	18.0			
20.0						2.60	3.80	3.10	3.90	3.20	3.60	3.30	3.40	3.30	20.0			
22.0						2.00	3.10	2.40	3.20	2.60	2.90	2.60	2.70	2.70	22.0			
24.0								1.90	2.70	2.00	2.40	2.10	2.20	2.10	24.0			
26.0								1.40	2.20	1.50	1.90	1.60	1.70	1.60	26.0			
28.0								1.00	1.90	1.10	1.50	1.20	1.30	1.20	28.0			
30.0								0.75	1.50	0.85	1.20	0.90	1.00	0.95	30.0			
32.0										0.55	0.95	0.60	0.75	0.65	32.0			
34.0											0.70		0.50		34.0			
36.0															36.0			
38.0															38.0			
1	0	50	0	100	0	100	0	100	0	100	50	100	84	100	1			
2	0	0	16	0	33	33	66	68	100	83	100	95	100	100	2			
3	0	0	16	0	33	33	66	68	100	83	100	95	100	100	3			
4	0	0	16	0	33	33	66	68	100	83	100	95	100	100	4			
MODE	1.2	1	2	1	2	1	2	1	2	1	2	1	2	1.2	MODE			
[DEG]	0~83.5												12~83.5	0~83.5	27~83.5	18~83.5	33~83.5	[DEG]
※13/10	7	5	7	5	5	4	4	4	4	4	4	4	4	4				
重荷重装置	35t																	



m	10.3	14.1	14.1	17.8	17.8	25.4	25.4	33.6	33.6	37.3	37.3	40.0	40.0	41.2	m	
1.8	※55.40	35.00	20.30	35.00	20.30	20.30	16.80								1.8	
2.1	※52.50	35.00	20.30	35.00	20.30	20.30	16.80								2.1	
2.5	49.00	35.00	20.30	35.00	20.30	20.30	16.80	14.00	12.00						2.5	
3.0	45.30	35.00	20.30	35.00	20.30	20.30	16.80	14.00	12.00	11.00	10.00				3.0	
3.5	42.00	35.00	20.30	35.00	20.30	20.30	16.80	14.00	12.00	11.00	10.00	7.60	7.60	7.20	3.5	
4.0	38.60	35.00	20.30	34.50	20.30	20.30	16.80	14.00	12.00	11.00	10.00	7.60	7.60	7.20	4.0	
4.5	35.00	34.70	20.30	32.50	20.30	20.30	16.80	14.00	12.00	11.00	10.00	7.60	7.60	7.20	4.5	
5.0	32.00	31.80	20.30	30.70	20.30	20.30	16.80	14.00	11.40	11.00	10.00	7.60	7.60	7.20	5.0	
5.5	29.30	29.10	20.30	29.00	20.30	20.30	16.80	14.00	10.80	11.00	10.00	7.60	7.60	7.20	5.5	
6.0	27.00	26.80	20.30	25.80	20.30	19.90	16.60	14.00	10.30	11.00	10.00	7.60	7.60	7.20	6.0	
6.5	24.00	23.50	20.30	22.20	20.30	19.00	15.80	14.00	9.80	11.00	10.00	7.60	7.60	7.20	6.5	
7.0	20.30	19.80	20.30	19.30	20.30	18.20	15.00	13.80	9.40	11.00	9.80	7.60	7.60	7.20	7.0	
8.0		14.80	16.40	14.50	17.00	15.20	13.70	12.90	8.60	11.00	9.00	7.60	7.60	7.20	8.0	
9.0		11.50	13.00	11.30	13.50	12.50	12.50	12.00	7.90	10.80	8.30	7.60	7.60	7.20	9.0	
10.0		9.20	10.60	9.00	11.10	10.20	11.50	10.50	7.30	10.10	7.70	7.60	7.60	7.20	10.0	
11.0		7.50	8.80	7.30	9.30	8.40	9.80	9.00	6.70	8.90	7.20	7.60	7.40	7.20	11.0	
12.0				6.00	7.90	7.00	8.40	7.60	6.30	7.70	6.70	7.60	7.00	7.10	12.0	
14.0				4.10	5.90	5.10	6.30	5.60	5.50	5.80	5.90	5.80	6.00	5.90	14.0	
16.0						3.70	4.90	4.20	4.90	4.40	4.80	4.50	4.60	4.50	16.0	
18.0						2.70	3.90	3.20	4.10	3.40	3.80	3.40	3.60	3.50	18.0	
20.0						2.00	3.10	2.50	3.30	2.60	3.00	2.70	2.80	2.70	20.0	
22.0						1.40	2.50	1.90	2.70	2.00	2.40	2.10	2.20	2.10	22.0	
24.0								1.40	2.20	1.50	1.90	1.60	1.70	1.60	24.0	
26.0								0.95	1.80	1.10	1.50	1.10	1.30	1.20	26.0	
28.0								0.60	1.40	0.75	1.10	0.80	0.95	0.85	28.0	
30.0									1.20		0.85	0.50	0.65	0.55	30.0	
32.0											0.60				32.0	
34.0															34.0	
36.0															36.0	
38.0															38.0	
1	0	50	0	100	0	100	0	100	0	100	50	100	84	100	1	
2	0	0	16	0	33	33	66	68	100	83	100	95	100	100	2	
3	0	0	16	0	33	33	66	68	100	83	100	95	100	100	3	
4	0	0	16	0	33	33	66	68	100	83	100	95	100	100	4	
MODE	1.2	1	2	1	2	1	2	1	2	1	2	1	2	1.2	MODE	
[DEG]		0~83.5						15~83.5	0~83.5	26~83.5	12~83.5	33~83.5	33~83.5	35~83.5		[DEG]
※13/10	7	5	7	5	5	4	4	4	4	4	4	4	4	4		
重荷重装置	35t															



m	10.3	14.1	14.1	17.8	17.8	25.4	25.4	33.6	33.6	37.3	37.3	40.0	40.0	41.2	m	
1.8	※55.40	35.00	20.30	35.00	20.30	20.30	16.80								1.8	
2.1	※52.50	35.00	20.30	35.00	20.30	20.30	16.80								2.1	
2.5	49.00	35.00	20.30	35.00	20.30	20.30	16.80	14.00	12.00						2.5	
3.0	44.00	35.00	20.30	35.00	20.30	20.30	16.80	14.00	12.00	11.00	10.00				3.0	
3.5	39.10	35.00	20.30	35.00	20.30	20.30	16.80	14.00	12.00	11.00	10.00	7.60	7.60	7.20	3.5	
4.0	35.10	34.90	20.30	34.50	20.30	20.30	16.80	14.00	12.00	11.00	10.00	7.60	7.60	7.20	4.0	
4.5	31.70	31.50	20.30	28.80	20.30	20.30	16.80	14.00	12.00	11.00	10.00	7.60	7.60	7.20	4.5	
5.0	28.50	28.20	20.30	23.80	20.30	20.30	16.80	14.00	11.40	11.00	10.00	7.60	7.60	7.20	5.0	
5.5	22.80	22.00	20.30	20.10	20.30	19.50	16.80	14.00	10.80	11.00	10.00	7.60	7.60	7.20	5.5	
6.0	18.80	18.40	20.20	17.20	20.20	17.00	16.60	14.00	10.30	11.00	10.00	7.60	7.60	7.20	6.0	
6.5	15.90	15.50	17.20	14.90	17.80	14.90	15.80	14.00	9.80	11.00	10.00	7.60	7.60	7.20	6.5	
7.0	13.60	13.30	14.80	13.00	15.40	13.30	15.00	12.90	9.40	11.00	9.80	7.60	7.60	7.20	7.0	
8.0		10.00	11.40	9.80	12.00	10.70	12.40	10.60	8.60	10.40	9.00	7.60	7.60	7.20	8.0	
9.0		7.80	9.10	7.60	9.60	8.70	10.20	8.80	7.90	8.70	8.30	7.60	7.60	7.20	9.0	
10.0		6.20	7.40	6.00	7.90	7.10	8.40	7.40	7.30	7.40	7.70	7.40	7.50	7.20	10.0	
11.0		5.00	6.20	4.80	6.60	5.80	7.10	6.30	6.70	6.30	6.80	6.30	6.50	6.30	11.0	
12.0				3.80	5.60	4.80	6.00	5.30	6.30	5.40	5.90	5.40	5.60	5.40	12.0	
14.0				2.40	4.10	3.30	4.50	3.80	4.70	4.00	4.40	4.10	4.20	4.10	14.0	
16.0						2.30	3.40	2.80	3.60	2.90	3.30	3.00	3.10	3.00	16.0	
18.0						1.50	2.60	2.00	2.80	2.20	2.50	2.20	2.30	2.30	18.0	
20.0						0.95	2.00	1.40	2.20	1.60	1.90	1.60	1.70	1.70	20.0	
22.0						0.50	1.60	0.95	1.70	1.00	1.40	1.10	1.20	1.20	22.0	
24.0								0.55	1.30	0.65	1.00	0.75	0.85	0.75	24.0	
26.0									1.00	0.70		0.50			26.0	
28.0									0.75						28.0	
30.0									0.50						30.0	
32.0															32.0	
34.0															34.0	
36.0															36.0	
38.0															38.0	
1	0	50	0	100	0	100	0	100	0	100	50	100	84	100	1	
2	0	0	16	0	33	33	66	68	100	83	100	95	100	100	2	
3	0	0	16	0	33	33	66	68	100	83	100	95	100	100	3	
4	0	0	16	0	33	33	66	68	100	83	100	95	100	100	4	
MODE	1.2	1	2	1	2	1	2	1	2	1	2	1	2	1.2	MODE	
[DEG]		0~83.5				3~83.5	0~83.5	35~83.5	0~83.5	43~83.5	37~83.5	47~83.5	44~83.5	47~83.5		[DEG]
※13/10	7	5	7	5	5	4	4	4	4	4	4	4	4	4		
重荷重装置	35t															



m	10.3	14.1	14.1	17.8	17.8	25.4	25.4	33.6	33.6	37.3	37.3	40.0	40.0	41.2	m									
1.8	※55.40	35.00	20.30	35.00	20.30	20.30	16.80								1.8									
2.1	※51.60	35.00	20.30	35.00	20.30	20.30	16.80								2.1									
2.5	45.90	35.00	20.30	35.00	20.30	20.30	16.80	14.00	12.00						2.5									
3.0	40.10	35.00	20.30	35.00	20.30	20.30	16.80	14.00	12.00	11.00	10.00				3.0									
3.5	35.40	33.20	20.30	29.50	20.30	20.30	16.80	14.00	12.00	11.00	10.00	7.60	7.60	7.20	3.5									
4.0	29.60	26.20	20.30	23.50	20.30	20.30	16.80	14.00	12.00	11.00	10.00	7.60	7.60	7.20	4.0									
4.5	23.50	21.30	20.30	19.30	20.30	18.50	16.80	14.00	12.00	11.00	10.00	7.60	7.60	7.20	4.5									
5.0	18.70	17.70	19.70	16.20	19.20	15.80	16.80	14.00	11.40	11.00	10.00	7.60	7.60	7.20	5.0									
5.5	15.40	15.00	16.70	13.70	16.60	13.70	15.60	13.10	10.80	11.00	10.00	7.60	7.60	7.20	5.5									
6.0	12.90	12.50	14.10	11.80	14.50	12.00	13.80	11.60	10.30	11.00	10.00	7.60	7.60	7.20	6.0									
6.5	11.00	10.60	12.10	10.20	12.60	10.60	12.30	10.40	9.80	10.20	10.00	7.60	7.60	7.20	6.5									
7.0	9.40	9.10	10.50	8.80	11.00	9.40	11.10	9.30	9.40	9.20	9.70	7.60	7.60	7.20	7.0									
8.0		6.80	8.10	6.60	8.60	7.50	9.10	7.60	8.60	7.50	8.10	7.50	7.60	7.20	8.0									
9.0			5.30	6.50	5.00	6.90	6.10	7.40	6.30	7.40	6.20	6.20	6.40	6.20	9.0									
10.0			4.10	5.20	3.90	5.70	4.90	6.10	5.20	6.30	5.20	5.70	5.20	5.40	10.0									
11.0			3.20	4.30	2.90	4.70	3.90	5.10	4.40	5.40	4.40	4.90	4.40	4.60	11.0									
12.0					2.20	3.90	3.20	4.30	3.70	4.60	3.70	4.20	3.70	3.90	12.0									
14.0					1.10	2.80	2.00	3.20	2.50	3.40	2.60	3.10	2.70	2.80	14.0									
16.0							1.20	2.30	1.70	2.50	1.80	2.20	1.90	2.00	16.0									
18.0						0.60	1.70	1.10	1.90	1.20	1.60	1.30	1.40	1.30	18.0									
20.0							1.20	0.60	1.40	0.75	1.10	0.80	0.95	0.85	20.0									
22.0							0.85		1.00		0.70				22.0									
24.0									0.70						24.0									
26.0															26.0									
28.0															28.0									
30.0															30.0									
32.0															32.0									
34.0															34.0									
36.0															36.0									
38.0															38.0									
1	0	50	0	100	0	100	0	100	0	100	50	100	84	100	1									
2	0	0	16	0	33	33	66	68	100	83	100	95	100	100	2									
3	0	0	16	0	33	33	66	68	100	83	100	95	100	100	3									
4	0	0	16	0	33	33	66	68	100	83	100	95	100	100	4									
MODE	1.2	1	2	1	2	1	2	1	2	1	2	1	2	1.2	MODE									
[DEG]		0~83.5				31~83.5		0~83.5		46~83.5		34~83.5		51~83.5		47~83.5		55~83.5		55~83.5		54~83.5		[DEG]
重荷重装置	35t																							



m	10.3	14.1	14.1	17.8	17.8	25.4	25.4	33.6	33.6	37.3	37.3	40.0	40.0	41.2	m
1.8	35.00	32.30	20.30	27.50	20.30	20.30	16.80								1.8
2.1	30.60	26.00	20.30	22.50	20.30	19.90	16.80								2.1
2.5	23.50	20.30	20.30	17.80	20.30	16.40	16.80	14.00	12.00						2.5
3.0	17.80	15.50	17.50	13.80	16.80	13.20	15.10	12.10	12.00	11.00	10.00				3.0
3.5	14.00	12.30	14.10	10.90	13.70	10.80	12.70	10.20	11.50	9.80	10.00	7.60	7.60	7.20	3.5
4.0	11.10	9.90	11.60	8.80	11.50	9.00	10.80	8.60	9.90	8.40	9.00	7.60	7.60	7.20	4.0
4.5	8.80	8.10	9.80	7.20	9.70	7.60	9.30	7.40	8.60	7.30	7.80	7.10	7.30	7.10	4.5
5.0	7.20	6.70	8.20	6.00	8.40	6.50	8.10	6.40	7.60	6.30	6.80	6.20	6.40	6.20	5.0
5.5	5.90	5.60	6.90	4.90	7.20	5.50	7.10	5.60	6.70	5.50	6.00	5.40	5.60	5.40	5.5
6.0	4.90	4.60	5.80	4.00	6.30	4.70	6.30	4.90	6.00	4.80	5.30	4.80	4.90	4.80	6.0
6.5	4.10	3.80	5.00	3.30	5.40	4.10	5.60	4.20	5.40	4.20	4.80	4.20	4.40	4.20	6.5
7.0	3.40	3.10	4.30	2.70	4.70	3.50	4.90	3.70	4.80	3.70	4.20	3.70	3.90	3.70	7.0
8.0		2.10	3.20	1.70	3.60	2.50	3.90	2.80	3.90	2.90	3.40	2.90	3.00	2.90	8.0
9.0		1.30	2.30	0.95	2.70	1.80	3.20	2.10	3.20	2.20	2.70	2.20	2.40	2.30	9.0
10.0		0.70	1.70		2.10	1.20	2.50	1.60	2.60	1.70	2.10	1.70	1.80	1.70	10.0
11.0			1.20		1.60	0.70	2.00	1.10	2.10	1.20	1.70	1.30	1.40	1.30	11.0
12.0					1.20		1.50	0.75	1.70	0.85	1.30	0.90	1.00	0.90	12.0
14.0					0.55		0.90		1.00		0.65				14.0
16.0									0.55						16.0
18.0															18.0
20.0															20.0
22.0															22.0
24.0															24.0
26.0															26.0
28.0															28.0
30.0															30.0
32.0															32.0
34.0															34.0
36.0															36.0
38.0															38.0
1	0	50	0	100	0	100	0	100	0	100	50	100	84	100	1
2	0	0	16	0	33	33	66	68	100	83	100	95	100	100	2
3	0	0	16	0	33	33	66	68	100	83	100	95	100	100	3
4	0	0	16	0	33	33	66	68	100	83	100	95	100	100	4
MODE	1.2	1	2	1	2	1	2	1	2	1	2	1	2	1.2	MODE
[DEG]	0~83.5	13~83.5	0~83.5	45~83.5	4~83.5	56~83.5	42~83.5	63~83.5	57~83.5	67~83.5	64~83.5	69~83.5	69~83.5	70~83.5	[DEG]
重荷重装置	35t														

■ジブ定格総荷重表

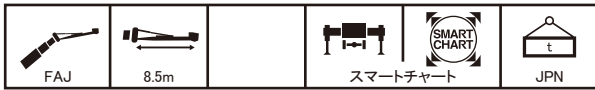

m		10.3	10.3	10.3	10.3	33.6	33.6	33.6	33.6	33.6	33.6	33.6	33.6	37.3	37.3	37.3	37.3	37.3	37.3	37.3	37.3	m	
°		5	25	45	60	5	25	45	60	5	25	45	60	5	25	45	60	5	25	45	60	°	
2.0	4.20																						2.0
3.0	4.20																						3.0
3.5	4.20																						3.5
4.0	4.20																						4.0
4.5	4.20	4.20				4.20				4.20													4.5
5.0	4.20	4.20				4.20				4.20				4.20				4.20					5.0
5.5	4.20	4.20				4.20				4.20				4.20				4.20					5.5
6.0	4.20	4.20				4.20				4.20				4.20				4.20					6.0
6.5	4.20	4.20	3.00			4.20				4.20				4.20				4.20					6.5
7.0	4.20	4.20	2.90			4.20				4.20				4.20				4.20					7.0
8.0	4.20	3.95	2.75	1.70		4.20	4.20			4.20	4.20			4.20				4.20					8.0
9.0	4.20	3.75	2.60	1.65		4.20	4.20			4.20	4.20			4.20	4.20			4.20	4.20				9.0
10.0	4.20	3.50	2.50	1.60		4.20	4.20	2.85		4.20	4.20			4.20	4.20			4.20	4.20				10.0
11.0	3.95	3.30	2.45	1.60		4.20	4.20	2.75	1.65	4.20	4.10	2.75	1.65	4.20	4.20	2.80		4.20	4.20	2.75			11.0
12.0	3.70	3.15	2.35			4.20	4.00	2.70	1.65	4.20	3.85	2.70	1.65	4.20	4.10	2.70	1.65	4.20	4.00	2.70	1.65		12.0
13.0	3.45	3.00	2.35			4.20	3.85	2.65	1.60	4.20	3.65	2.65	1.60	4.20	3.95	2.65	1.60	4.20	3.75	2.65	1.60		13.0
14.0	3.25	2.90				4.20	3.70	2.60	1.60	4.05	3.45	2.60	1.60	4.20	3.80	2.60	1.60	4.20	3.60	2.60	1.60		14.0
16.0						4.20	3.45	2.45	1.55	3.50	3.10	2.45	1.55	4.20	3.55	2.50	1.55	4.20	3.25	2.50	1.55		16.0
18.0						4.20	3.20	2.35	1.55	3.00	2.80	2.35	1.55	4.20	3.30	2.40	1.55	4.20	3.45	2.95	2.40	1.55	18.0
20.0						3.85	3.00	2.25	1.50	2.65	2.50	2.25	1.50	3.90	3.10	2.30	1.50	2.90	2.70	2.30	1.50		20.0
22.0						3.30	2.85	2.15	1.50	2.30	2.20	2.15	1.50	3.35	2.90	2.20	1.50	2.55	2.40	2.20	1.50		22.0
24.0						2.60	2.70	2.10		2.05	1.95	1.90		2.60	2.75	2.10	1.50	2.25	2.15	2.05	1.45		24.0
26.0						2.00	2.25	2.05		1.80	1.75	1.70		2.05	2.30	2.05		2.00	1.90	1.85			26.0
28.0						1.50	1.70	1.85		1.55	1.55	1.50		1.55	1.75	1.90		1.80	1.70	1.65			28.0
30.0						1.10	1.30			1.40	1.35			1.15	1.35	1.45		1.45	1.55	1.50			30.0
32.0						0.75	0.90			1.20	1.20			0.80	0.95	1.05		1.10	1.25	1.30			32.0
34.0						0.45	0.55			1.05	1.05			0.50	0.65			0.80	0.95				34.0
36.0										0.85	0.90							0.55	0.65				36.0
38.0																			0.35				38.0
40.0																							40.0
42.0																							42.0
1	0	0	0	0		100	100	100	100	0	0	0	0	100	100	100	100	50	50	50	50		1
2	0	0	0	0		68	68	68	68	100	100	100	100	83	83	83	83	100	100	100	100		2
3	0	0	0	0		68	68	68	68	100	100	100	100	83	83	83	83	100	100	100	100		3
4	0	0	0	0		68	68	68	68	100	100	100	100	83	83	83	83	100	100	100	100		4
MODE		1,2				1				2				1				2					MODE
[DEG]		30~83.5	36~83.5	49~83.5	63~83.5	33~83.5	36~83.5	52~83.5	64~83.5	27~83.5	30~83.5	53~83.5	65~83.5	41~83.5	44~83.5	50~83.5	64~83.5	37~83.5	35~83.5	50~83.5	64~83.5	[DEG]	

m		40.0	40.0	40.0	40.0	40.0	40.0	40.0	40.0	41.2	41.2	41.2	41.2										m
°		5	25	45	60	5	25	45	60	5	25	45	60										°
2.0																							2.0
3.0																							3.0
3.5																							3.5
4.0																							4.0
4.5																							4.5
5.0																							5.0
5.5																							5.5
6.0	4.00					4.00				3.80													6.0
6.5	4.00					4.00				3.80													6.5
7.0	4.00					4.00				3.80													7.0
8.0	4.00					4.00				3.80													8.0
9.0	4.00					4.00				3.80													9.0
10.0	4.00	4.00				4.00	4.00			3.80	3.80												10.0
11.0	4.00	4.00				4.00	4.00			3.80	3.80												11.0
12.0	4.00	4.00	2.70	1.65		4.00	4.00	2.70	1.65	3.80	3.80	2.75											12.0
13.0	4.00	4.00	2.65	1.60		4.00	3.85	2.65	1.60	3.80	3.80	2.65	1.60										13.0
14.0	4.00	3.85	2.60	1.60		4.00	3.65	2.60	1.60	3.80	3.70	2.60	1.60										14.0
16.0	4.00	3.60	2.50	1.55		3.95	3.30	2.50	1.55	3.80	3.35	2.50	1.55										16.0
18.0	4.00	3.35	2.40	1.55		3.45	3.05	2.40	1.55	3.55	3.05	2.40	1.55										18.0
20.0	3.75	3.15	2.30	1.50		3.05	2.80	2.30	1.50	3.10	2.80	2.30	1.50										20.0
22.0	3.20	2.95	2.20	1.50		2.70	2.50	2.20	1.50	2.80	2.55	2.20	1.50										22.0
24.0	2.65	2.80	2.10	1.45		2.40	2.25	2.10	1.45	2.50	2.30	2.15	1.45										24.0
26.0	2.05	2.30	2.05			2.15	2.05	1.95		2.05	2.10	2.00	1.45										26.0
28.0	1.55	1.80	1.95			1.65	1.85	1.75		1.60	1.80	1.80											28.0
30.0	1.15	1.35	1.50			1.25	1.45	1.55		1.20	1.40	1.50											30.0
32.0	0.85	1.00	1.10			0.90	1.10	1.15		0.85	1.00	1.10											32.0
34.0	0.50	0.70	0.75			0.60	0.75	0.80		0.55	0.70	0.75											34.0
36.0							0.45																36.0
38.0																							38.0
40.0																							40.0
42.0																							42.0
1	100	100	100	100		84	84	84	84	100	100	100	100										1
2	95	95	95	95		100	100	100	100	100	100	100	100										2
3	95	95	95	95		100	100	100	100	100	100	100	100										3
4	95	95	95	95		100	100	100	100	100	100	100	100										4
MODE		1				2				1,2													MODE
[DEG]		45~83.5	48~83.5	50~83.5	67~83.5	44~83.5	45~83.5	50~83.5	67~83.5	47~83.5	50~83.5	52~83.5	64~83.5										[DEG]

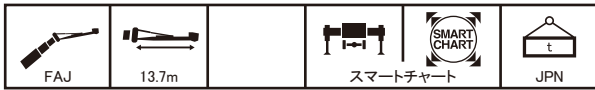

m		10.3	10.3	10.3	10.3	33.6	33.6	33.6	33.6	33.6	33.6	33.6	33.6	37.3	37.3	37.3	37.3	37.3	37.3	37.3	37.3	m		
°		5	25	45	60	5	25	45	60	5	25	45	60	5	25	45	60	5	25	45	60	°		
2.0																						2.0		
3.0	3.20																					3.0		
3.5	3.20																					3.5		
4.0	3.20																					4.0		
4.5	3.20																					4.5		
5.0	3.20																					5.0		
5.5	3.20																					5.5		
6.0	3.20					3.20				3.00												6.0		
6.5	3.20					3.20				3.00				3.00						2.90		6.5		
7.0	3.20					3.20				3.00				3.00						2.90		7.0		
8.0	3.05	2.35				3.20				3.00				3.00						2.90		8.0		
9.0	2.75	2.20				3.20				3.00				3.00						2.90		9.0		
10.0	2.55	2.05				3.20				3.00				3.00						2.90		10.0		
11.0	2.35	1.90				3.20				3.00				3.00						2.90		11.0		
12.0	2.15	1.80	1.55			3.20	2.20			3.00	2.20			3.00	2.25					2.90	2.20	12.0		
13.0	2.00	1.70	1.50	0.90		3.10	2.15			3.00	2.15			3.00	2.15					2.90	2.15	13.0		
14.0	1.85	1.65	1.45	0.90		2.95	2.10			2.95	2.10			3.00	2.10					2.90	2.10	14.0		
16.0	1.65	1.50	1.35	0.85		2.70	1.95	1.50		2.70	1.95	1.50		2.80	2.00	1.50				2.80	2.00	1.50	16.0	
18.0	1.50	1.40	1.30			2.55	1.85	1.40	0.85	2.50	1.85	1.40	0.85	2.60	1.90	1.45	0.85			2.60	1.90	1.45	0.85	18.0
20.0	1.35	1.30				2.35	1.75	1.35	0.85	2.35	1.75	1.35	0.80	2.40	1.80	1.35	0.85			2.40	1.80	1.35	0.85	20.0
22.0						2.20	1.65	1.25	0.80	2.20	1.65	1.25	0.80	2.30	1.70	1.30	0.80			2.25	1.70	1.30	0.80	22.0
24.0						2.10	1.60	1.20	0.80	2.10	1.60	1.20	0.80	2.15	1.65	1.20	0.80			2.10	1.65	1.20	0.80	24.0
26.0						1.95	1.50	1.15	0.80	1.95	1.50	1.15	0.80	2.05	1.55	1.15	0.80			1.90	1.55	1.15	0.80	26.0
28.0						1.80	1.45	1.10	0.80	1.80	1.45	1.10	0.80	1.90	1.50	1.10	0.75			1.70	1.50	1.10	0.75	28.0
30.0						1.55	1.35	1.05		1.35	1.35	1.05		1.55	1.40	1.05	0.75			1.50	1.40	1.05	0.75	30.0
32.0						1.20	1.30	1.00		1.20	1.20	1.00		1.20	1.30	1.00				1.35	1.30	1.00		32.0
34.0						0.90	1.15	0.95		1.05	1.05	0.95		0.90	1.15	1.00				1.20	1.20	1.00		34.0
36.0						0.65	0.85			0.95	0.95			0.65	0.85	0.95				0.90	1.05	0.95		36.0
38.0						0.40	0.55			0.85	0.85			0.40	0.60					0.70	0.85	0.90		38.0
40.0										0.75	0.75									0.50	0.60			40.0
42.0										0.55										0.40				42.0
MODE		1	2	3	4	1	2	3	4	1	2	3	4	1	2	3	4	1	2	3	4	MODE		
[DEG]		23~83.5	35~83.5	54~83.5	67~83.5	36~83.5	42~83.5	53~83.5	64~83.5	25~83.5	38~83.5	53~83.5	65~83.5	43~83.5	48~83.5	54~83.5	64~83.5	39~83.5	41~83.5	51~83.5	64~83.5	[DEG]		

m		40.0	40.0	40.0	40.0	40.0	40.0	40.0	40.0	41.2	41.2	41.2	41.2									m
°		5	25	45	60	5	25	45	60	5	25	45	60									°
2.0																						2.0
3.0																						3.0
3.5																						3.5
4.0																						4.0
4.5																						4.5
5.0																						5.0
5.5																						5.5
6.0																						6.0
6.5																						6.5
7.0	3.00					2.80				2.50												7.0
8.0	3.00					2.80				2.50												8.0
9.0	3.00					2.80				2.50												9.0
10.0	3.00					2.80				2.50												10.0
11.0	3.00					2.80				2.50												11.0
12.0	3.00					2.80				2.50												12.0
13.0	3.00	2.15				2.80	2.15			2.50	2.15											13.0
14.0	3.00	2.10				2.80	2.10			2.50	2.10											14.0
16.0	2.85	2.00				2.80	2.00			2.50	2.00											16.0
18.0	2.65	1.90	1.45	0.85		2.65	1.90	1.45	0.85	2.50	1.90	1.45	0.85									18.0
20.0	2.45	1.80	1.40	0.85		2.45	1.80	1.40	0.85	2.50	1.80	1.40	0.85									20.0
22.0	2.30	1.75	1.30	0.80		2.30	1.75	1.30	0.80	2.35	1.75	1.30	0.80									22.0
24.0	2.20	1.65	1.25	0.80		2.20	1.65	1.25	0.80	2.20	1.65	1.25	0.80									24.0
26.0	2.05	1.60	1.20	0.80		2.00	1.60	1.20	0.75	2.05	1.60	1.20	0.75									26.0
28.0	1.95	1.50	1.10	0.75		1.80	1.50	1.10	0.75	1.85	1.55	1.15	0.75									28.0
30.0	1.55	1.45	1.05	0.75		1.60	1.45	1.05	0.75	1.55	1.45	1.10	0.75									30.0
32.0	1.20	1.35	1.05			1.30	1.35	1.05		1.20	1.35	1.05	0.75									32.0
34.0	0.90	1.20	1.00			1.00	1.25	1.00		0.90	1.20	1.00										34.0
36.0	0.65	0.90	0.95			0.75	0.95	0.95		0.65	0.90	0.95										36.0
38.0		0.65	0.75			0.50	0.70	0.80			0.65	0.75										38.0
40.0			0.45				0.45	0.55				0.50										40.0
42.0																						42.0
MODE		1	2	3	4	1	2	3	4	1	2	3	4									MODE
[DEG]		50~83.5	52~83.5	51~83.5	67~83.5	47~83.5	49~83.5	51~83.5	67~83.5	51~83.5	54~83.5	53~83.5	65~83.5									[DEG]

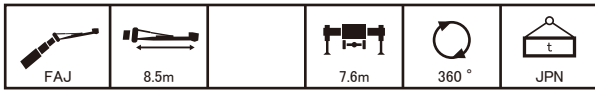

m		10.3	10.3	10.3	10.3	33.6	33.6	33.6	33.6	33.6	33.6	33.6	33.6	37.3	37.3	37.3	37.3	37.3	37.3	37.3	37.3	m				
°		5	25	45	60	5	25	45	60	5	25	45	60	5	25	45	60	5	25	45	60	°				
2.0	4.20																						2.0			
3.0	4.20																						3.0			
3.5	4.20																						3.5			
4.0	4.20																						4.0			
4.5	4.20	4.20				4.20																	4.5			
5.0	4.20	4.20				4.20				4.20													5.0			
5.5	4.20	4.20				4.20				4.20				4.20							4.20		5.5			
6.0	4.20	4.20				4.20				4.20				4.20							4.20		6.0			
6.5	4.20	4.20	3.00			4.20				4.20				4.20							4.20		6.5			
7.0	4.20	4.20	2.90			4.20				4.20				4.20							4.20		7.0			
8.0	4.20	3.95	2.75	1.70		4.20	4.20			4.20	4.20			4.20							4.20		8.0			
9.0	4.20	3.75	2.60	1.65		4.20	4.20			4.20	4.20			4.20	4.20						4.20	4.20	9.0			
10.0	4.20	3.50	2.50	1.60		4.20	4.20	2.85		4.20	4.20			4.20	4.20						4.20	4.20	10.0			
11.0	3.95	3.30	2.45	1.60		4.20	4.20	2.75	1.65	4.20	4.10	2.75	1.65	4.20	4.20	2.80					4.20	4.20	2.75	11.0		
12.0	3.70	3.15	2.35			4.20	4.00	2.70	1.65	4.20	3.85	2.70	1.65	4.20	4.10	2.70	1.65				4.20	4.00	2.70	1.65	12.0	
13.0	3.45	3.00	2.35			4.20	3.85	2.65	1.60	4.20	3.65	2.65	1.60	4.20	3.95	2.65	1.60				4.20	3.75	2.65	1.60	13.0	
14.0	3.25	2.90				4.20	3.70	2.60	1.60	4.05	3.45	2.60	1.60	4.20	3.80	2.60	1.60				4.20	3.60	2.60	1.60	14.0	
16.0						4.20	3.45	2.45	1.55	3.50	3.10	2.45	1.55	4.20	3.55	2.50	1.55				4.20	3.25	2.50	1.55	16.0	
18.0						4.20	3.20	2.35	1.55	3.00	2.80	2.35	1.55	4.20	3.30	2.40	1.55				4.20	3.45	2.95	2.40	1.55	18.0
20.0						3.40	3.00	2.25	1.50	2.65	2.50	2.25	1.50	3.45	3.10	2.30	1.50				2.90	2.70	2.30	1.50	20.0	
22.0						2.65	2.85	2.15	1.50	2.30	2.20	2.15	1.50	2.70	2.90	2.20	1.50				2.55	2.40	2.20	1.50	22.0	
24.0						2.05	2.30	2.10		2.05	1.95	1.90		2.10	2.35	2.10	1.50				2.25	2.15	2.05	1.45	24.0	
26.0						1.55	1.80	1.90		1.80	1.75	1.70		1.60	1.85	2.00					1.90	1.90	1.85		26.0	
28.0						1.10	1.35	1.45		1.55	1.55	1.50		1.15	1.40	1.50					1.45	1.65	1.65		28.0	
30.0						0.75	0.95			1.40	1.35			0.80	1.00	1.10					1.10	1.30	1.35		30.0	
32.0						0.40	0.55			1.10	1.20			0.45	0.65	0.70					0.75	0.95	1.00		32.0	
34.0										0.80	0.90										0.50	0.60			34.0	
36.0										0.55	0.60														36.0	
38.0																									38.0	
40.0																									40.0	
42.0																									42.0	
1	0	0	0	0		100	100	100	100	0	0	0	0	100	100	100	100				50	50	50	50	1	
2	0	0	0	0		68	68	68	68	100	100	100	100	83	83	83	83				100	100	100	100	2	
3	0	0	0	0		68	68	68	68	100	100	100	100	83	83	83	83				100	100	100	100	3	
4	0	0	0	0		68	68	68	68	100	100	100	100	83	83	83	83				100	100	100	100	4	
MODE		1,2				1				2				1				2				MODE				
[DEG]		30~83.5	38~83.5	49~83.5	63~83.5	38~83.5	42~83.5	52~83.5	64~83.5	27~83.5	30~83.5	53~83.5	65~83.5	45~83.5	48~83.5	50~83.5	64~83.5	41~83.5	44~83.5	50~83.5	64~83.5	[DEG]				

m		40.0	40.0	40.0	40.0	40.0	40.0	40.0	40.0	41.2	41.2	41.2	41.2											m	
°		5	25	45	60	5	25	45	60	5	25	45	60											°	
2.0																								2.0	
3.0																								3.0	
3.5																								3.5	
4.0																								4.0	
4.5																								4.5	
5.0																								5.0	
5.5																								5.5	
6.0	4.00					4.00				3.80														6.0	
6.5	4.00					4.00				3.80														6.5	
7.0	4.00					4.00				3.80														7.0	
8.0	4.00					4.00				3.80														8.0	
9.0	4.00					4.00				3.80														9.0	
10.0	4.00	4.00				4.00	4.00			3.80	3.80													10.0	
11.0	4.00	4.00				4.00	4.00			3.80	3.80													11.0	
12.0	4.00	4.00	2.70	1.65		4.00	4.00	2.70	1.65	3.80	3.80	2.75												12.0	
13.0	4.00	4.00	2.65	1.60		4.00	3.85	2.65	1.60	3.80	3.80	2.65	1.60											13.0	
14.0	4.00	3.85	2.60	1.60		4.00	3.65	2.60	1.60	3.80	3.70	2.60	1.60											14.0	
16.0	4.00	3.60	2.50	1.55		3.95	3.30	2.50	1.55	3.80	3.35	2.50	1.55											16.0	
18.0	4.00	3.35	2.40	1.55		3.45	3.05	2.40	1.55	3.55	3.05	2.40	1.55											18.0	
20.0	3.45	3.15	2.30	1.50		3.05	2.80	2.30	1.50	3.10	2.80	2.30	1.50											20.0	
22.0	2.70	2.95	2.20	1.50		2.70	2.50	2.20	1.50	2.70	2.55	2.20	1.50											22.0	
24.0	2.10	2.40	2.10	1.45		2.20	2.25	2.10	1.45	2.10	2.30	2.15	1.45											24.0	
26.0	1.60	1.85	2.05			1.70	1.95	1.95		1.60	1.85	2.00	1.45											26.0	
28.0	1.15	1.40	1.55			1.25	1.50	1.65		1.20	1.45	1.55												28.0	
30.0	0.80	1.00	1.15			0.90	1.10	1.20		0.80	1.05	1.15												30.0	
32.0	0.45	0.65	0.75			0.55	0.75	0.85		0.50	0.70	0.80												32.0	
34.0			0.40				0.45	0.50				0.45												34.0	
36.0																								36.0	
38.0																								38.0	
40.0																								40.0	
42.0																								42.0	
1	100	100	100	100		84	84	84	84	100	100	100	100											1	
2	95	95	95	95		100	100	100	100	100	100	100	100											2	
3	95	95	95	95		100	100	100	100	100	100	100	100											3	
4	95	95	95	95		100	100	100	100	100	100	100	100											4	
MODE		1				2				1,2															MODE
[DEG]		49~83.5	52~83.5	67~83.5		47~83.5	48~83.5	50~83.5	67~83.5	50~83.5	53~83.5	52~83.5	64~83.5											[DEG]	

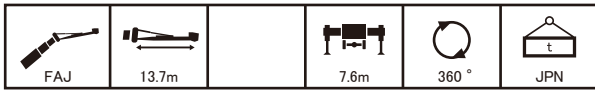

m		10.3	10.3	10.3	10.3	33.6	33.6	33.6	33.6	33.6	33.6	33.6	33.6	37.3	37.3	37.3	37.3	37.3	37.3	37.3	37.3	m	
°		5	25	45	60	5	25	45	60	5	25	45	60	5	25	45	60	5	25	45	60	°	
2.0																						2.0	
3.0		3.20																				3.0	
3.5		3.20																				3.5	
4.0		3.20																				4.0	
4.5		3.20																				4.5	
5.0		3.20																				5.0	
5.5		3.20																				5.5	
6.0		3.20				3.20				3.00												6.0	
6.5		3.20				3.20				3.00				3.00						2.90		6.5	
7.0		3.20				3.20				3.00				3.00						2.90		7.0	
8.0		3.05	2.35			3.20				3.00				3.00						2.90		8.0	
9.0		2.75	2.20			3.20				3.00				3.00						2.90		9.0	
10.0		2.55	2.05			3.20				3.00				3.00						2.90		10.0	
11.0		2.35	1.90			3.20				3.00				3.00						2.90		11.0	
12.0		2.15	1.80	1.55		3.20	2.20			3.00	2.20			3.00	2.25				2.90	2.20		12.0	
13.0		2.00	1.70	1.50	0.90	3.10	2.15			3.00	2.15			3.00	2.15				2.90	2.15		13.0	
14.0		1.85	1.65	1.45	0.90	2.95	2.10			2.95	2.10			3.00	2.10				2.90	2.10		14.0	
16.0		1.65	1.50	1.35	0.85	2.70	1.95	1.50		2.70	1.95	1.50		2.80	2.00	1.50			2.80	2.00	1.50	16.0	
18.0		1.50	1.40	1.30		2.55	1.85	1.40	0.85	2.50	1.85	1.40	0.85	2.60	1.90	1.45	0.85		2.60	1.90	1.45	0.85	18.0
20.0		1.35	1.30			2.35	1.75	1.35	0.85	2.35	1.75	1.35	0.85	2.40	1.80	1.35	0.85		2.40	1.80	1.35	0.85	20.0
22.0						2.20	1.65	1.25	0.80	2.20	1.65	1.25	0.80	2.30	1.70	1.30	0.80		2.25	1.70	1.30	0.80	22.0
24.0						2.10	1.60	1.20	0.80	1.95	1.60	1.20	0.80	2.15	1.65	1.20	0.80		2.10	1.65	1.20	0.80	24.0
26.0						1.95	1.50	1.15	0.80	1.70	1.50	1.15	0.80	2.00	1.55	1.15	0.80		1.90	1.55	1.15	0.80	26.0
28.0						1.60	1.45	1.10	0.80	1.50	1.45	1.10	0.80	1.60	1.50	1.10	0.75		1.70	1.50	1.10	0.75	28.0
30.0						1.25	1.35	1.05		1.35	1.35	1.05		1.20	1.40	1.05	0.75		1.50	1.40	1.05	0.75	30.0
32.0						0.90	1.20	1.00		1.20	1.20	1.00		0.90	1.20	1.00			1.15	1.30	1.00		32.0
34.0						0.60	0.85	0.95		1.05	1.05	0.95		0.60	0.90	1.00			0.90	1.10	1.00		34.0
36.0										0.90	0.95				0.60	0.70			0.65	0.85	0.95		36.0
38.0										0.70	0.85								0.40	0.60	0.65		38.0
40.0										0.50	0.60												40.0
42.0																							42.0
1	0	0	0	0	0	100	100	100	100	0	0	0	0	100	100	100	100	50	50	50	50	1	
2	0	0	0	0	0	68	68	68	68	100	100	100	100	83	83	83	83	100	100	100	100	2	
3	0	0	0	0	0	68	68	68	68	100	100	100	100	83	83	83	83	100	100	100	100	3	
4	0	0	0	0	0	68	68	68	68	100	100	100	100	83	83	83	83	100	100	100	100	4	
MODE		1,2				1				2				1				2				MODE	
[DEG]		23~83.5	35~83.5	54~83.5	67~83.5	45~83.5	46~83.5	53~83.5	64~83.5	32~83.5	38~83.5	53~83.5	65~83.5	50~83.5	52~83.5	54~83.5	64~83.5	43~83.5	49~83.5	51~83.5	64~83.5	[DEG]	

m		40.0	40.0	40.0	40.0	40.0	40.0	40.0	40.0	41.2	41.2	41.2	41.2									m	
°		5	25	45	60	5	25	45	60	5	25	45	60									°	
2.0																						2.0	
3.0																						3.0	
3.5																						3.5	
4.0																						4.0	
4.5																						4.5	
5.0																						5.0	
5.5																						5.5	
6.0																						6.0	
6.5																						6.5	
7.0		3.00				2.80				2.50												7.0	
8.0		3.00				2.80				2.50												8.0	
9.0		3.00				2.80				2.50												9.0	
10.0		3.00				2.80				2.50												10.0	
11.0		3.00				2.80				2.50												11.0	
12.0		3.00				2.80				2.50												12.0	
13.0		3.00	2.15			2.80	2.15			2.50	2.15											13.0	
14.0		3.00	2.10			2.80	2.10			2.50	2.10											14.0	
16.0		2.85	2.00			2.80	2.00			2.50	2.00											16.0	
18.0		2.65	1.90	1.45	0.85	2.65	1.90	1.45	0.85	2.50	1.90	1.45	0.85									18.0	
20.0		2.45	1.80	1.40	0.85	2.45	1.80	1.40	0.85	2.50	1.80	1.40	0.85									20.0	
22.0		2.30	1.75	1.30	0.80	2.30	1.75	1.30	0.80	2.35	1.75	1.30	0.80									22.0	
24.0		2.20	1.65	1.25	0.80	2.20	1.65	1.25	0.80	2.20	1.65	1.25	0.80									24.0	
26.0		2.00	1.60	1.20	0.80	2.00	1.60	1.20	0.75	2.00	1.60	1.20	0.75									26.0	
28.0		1.60	1.50	1.10	0.75	1.65	1.50	1.10	0.75	1.60	1.55	1.15	0.75									28.0	
30.0		1.20	1.45	1.05	0.75	1.30	1.45	1.05	0.75	1.20	1.45	1.10	0.75									30.0	
32.0		0.90	1.20	1.05		0.95	1.25	1.05		0.90	1.20	1.05	0.75									32.0	
34.0		0.60	0.90	1.00		0.70	0.95	1.00		0.60	0.90	1.00										34.0	
36.0			0.60	0.75		0.45	0.70	0.80			0.60	0.75										36.0	
38.0				0.45			0.40	0.55				0.45										38.0	
40.0																						40.0	
42.0																						42.0	
1	100	100	100	100	84	84	84	84	100	100	100	100										1	
2	95	95	95	95	100	100	100	100	100	100	100	100	100									2	
3	95	95	95	95	100	100	100	100	100	100	100	100	100									3	
4	95	95	95	95	100	100	100	100	100	100	100	100	100									4	
MODE		1				2				1,2													MODE
[DEG]		63~83.5	55~83.5	54~83.5	67~83.5	50~83.5	52~83.5	55~83.5	67~83.5	54~83.5	56~83.5	56~83.5	65~83.5									[DEG]	

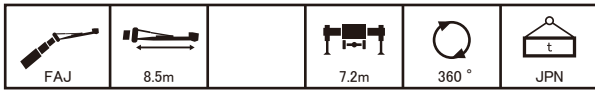

m		10.3	10.3	10.3	10.3	33.6	33.6	33.6	33.6	33.6	33.6	33.6	33.6	37.3	37.3	37.3	37.3	37.3	37.3	37.3	37.3	m			
°		5	25	45	60	5	25	45	60	5	25	45	60	5	25	45	60	5	25	45	60	°			
2.0	4.20																						2.0		
3.0	4.20																						3.0		
3.5	4.20																						3.5		
4.0	4.20																						4.0		
4.5	4.20	4.20				4.20																	4.5		
5.0	4.20	4.20				4.20				4.20													5.0		
5.5	4.20	4.20				4.20				4.20				4.20							4.20		5.5		
6.0	4.20	4.20				4.20				4.20				4.20							4.20		6.0		
6.5	4.20	4.20	3.00			4.20				4.20				4.20							4.20		6.5		
7.0	4.20	4.20	2.90			4.20				4.20				4.20							4.20		7.0		
8.0	4.20	3.95	2.75	1.70		4.20	4.20			4.20	4.20			4.20							4.20		8.0		
9.0	4.20	3.75	2.60	1.65		4.20	4.20			4.20	4.20			4.20	4.20						4.20	4.20	9.0		
10.0	4.20	3.50	2.50	1.60		4.20	4.20	2.85		4.20	4.20			4.20	4.20						4.20	4.20	10.0		
11.0	3.95	3.30	2.45	1.60		4.20	4.20	2.75	1.65	4.20	4.10	2.75	1.65	4.20	4.20	2.80					4.20	4.20	2.75	11.0	
12.0	3.70	3.15	2.35			4.20	4.00	2.70	1.65	4.20	3.85	2.70	1.65	4.20	4.10	2.70	1.65				4.20	4.00	2.70	1.65	12.0
13.0	3.45	3.00	2.35			4.20	3.85	2.65	1.60	4.20	3.65	2.65	1.60	4.20	3.95	2.65	1.60				4.20	3.75	2.65	1.60	13.0
14.0	3.25	2.90				4.20	3.70	2.60	1.60	4.05	3.45	2.60	1.60	4.20	3.80	2.60	1.60				4.20	3.60	2.60	1.60	14.0
16.0						4.20	3.45	2.45	1.55	3.50	3.10	2.45	1.55	4.20	3.55	2.50	1.55				4.20	3.25	2.50	1.55	16.0
18.0						4.00	3.20	2.35	1.55	3.00	2.80	2.35	1.55	4.00	3.30	2.40	1.55				3.45	2.95	2.40	1.55	18.0
20.0						3.10	3.00	2.25	1.50	2.65	2.50	2.25	1.50	3.15	3.10	2.30	1.50				2.90	2.70	2.30	1.50	20.0
22.0						2.40	2.70	2.15	1.50	2.30	2.20	2.15	1.50	2.40	2.75	2.20	1.50				2.55	2.40	2.20	1.50	22.0
24.0						1.80	2.10	2.10		2.05	1.95	1.90		1.80	2.15	2.10	1.50				2.15	2.15	2.05	1.45	24.0
26.0						1.30	1.55	1.70		1.80	1.75	1.70		1.30	1.60	1.75					1.65	1.90	1.85		26.0
28.0						0.90	1.10	1.20		1.55	1.55	1.50		0.90	1.15	1.30					1.20	1.45	1.55		28.0
30.0						0.55	0.70			1.15	1.30			0.55	0.75	0.85					0.85	1.05	1.15		30.0
32.0										0.85	1.00				0.45	0.50					0.55	0.70	0.80		32.0
34.0										0.60	0.70											0.45			34.0
36.0											0.45														36.0
38.0																									38.0
40.0																									40.0
42.0																									42.0
1	0	0	0	0		100	100	100	100	0	0	0	0	100	100	100	100				50	50	50	50	1
2	0	0	0	0		68	68	68	68	100	100	100	100	83	83	83	83				100	100	100	100	2
3	0	0	0	0		68	68	68	68	100	100	100	100	83	83	83	83				100	100	100	100	3
4	0	0	0	0		68	68	68	68	100	100	100	100	83	83	83	83				100	100	100	100	4
MODE		1,2				1				2				1				2				MODE			
[DEG]		30~83.5	38~83.5	49~83.5	63~83.5	43~83.5	46~83.5	52~83.5	64~83.5	33~83.5	30~83.5	53~83.5	65~83.5	49~83.5	48~83.5	50~83.5	64~83.5	45~83.5	44~83.5	50~83.5	64~83.5	[DEG]			

m		40.0	40.0	40.0	40.0	40.0	40.0	40.0	40.0	41.2	41.2	41.2	41.2											m	
°		5	25	45	60	5	25	45	60	5	25	45	60											°	
2.0																								2.0	
3.0																								3.0	
3.5																								3.5	
4.0																								4.0	
4.5																								4.5	
5.0																								5.0	
5.5																								5.5	
6.0	4.00					4.00				3.80														6.0	
6.5	4.00					4.00				3.80														6.5	
7.0	4.00					4.00				3.80														7.0	
8.0	4.00					4.00				3.80														8.0	
9.0	4.00					4.00				3.80														9.0	
10.0	4.00	4.00				4.00	4.00			3.80	3.80													10.0	
11.0	4.00	4.00				4.00	4.00			3.80	3.80													11.0	
12.0	4.00	4.00	2.70	1.65		4.00	4.00	2.70	1.65	3.80	3.80	2.75												12.0	
13.0	4.00	4.00	2.65	1.60		4.00	3.85	2.65	1.60	3.80	3.80	2.65	1.60											13.0	
14.0	4.00	3.85	2.60	1.60		4.00	3.65	2.60	1.60	3.80	3.70	2.60	1.60											14.0	
16.0	4.00	3.60	2.50	1.55		3.95	3.30	2.50	1.55	3.80	3.35	2.50	1.55											16.0	
18.0	3.95	3.35	2.40	1.55		3.45	3.05	2.40	1.55	3.55	3.05	2.40	1.55											18.0	
20.0	3.10	3.15	2.30	1.50		3.05	2.80	2.30	1.50	3.10	2.80	2.30	1.50											20.0	
22.0	2.40	2.80	2.20	1.50		2.50	2.50	2.20	1.50	2.40	2.55	2.20	1.50											22.0	
24.0	1.85	2.15	2.10	1.45		1.95	2.25	2.10	1.45	1.85	2.15	2.15	1.45											24.0	
26.0	1.35	1.60	1.80			1.45	1.70	1.90		1.35	1.65	1.85	1.45											26.0	
28.0	0.95	1.15	1.35			1.00	1.25	1.40		0.95	1.20	1.35												28.0	
30.0	0.60	0.80	0.90			0.65	0.90	1.00		0.60	0.80	0.95												30.0	
32.0		0.45	0.55				0.55	0.65			0.45	0.55												32.0	
34.0																								34.0	
36.0																								36.0	
38.0																								38.0	
40.0																								40.0	
42.0																								42.0	
1	100	100	100	100		84	84	84	84	100	100	100	100											1	
2	95	95	95	95		100	100	100	100	100	100	100	100											2	
3	95	95	95	95		100	100	100	100	100	100	100	100											3	
4	95	95	95	95		100	100	100	100	100	100	100	100											4	
MODE		1				2				1,2															MODE
[DEG]		52~83.5	52~83.5	53~83.5	67~83.5	50~83.5	52~83.5	53~83.5	67~83.5	53~83.5	53~83.5	55~83.5	64~83.5											[DEG]	

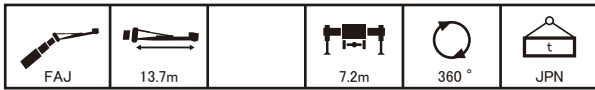

m		10.3	10.3	10.3	10.3	33.6	33.6	33.6	33.6	33.6	33.6	33.6	33.6	37.3	37.3	37.3	37.3	37.3	37.3	37.3	37.3	m		
°		5	25	45	60	5	25	45	60	5	25	45	60	5	25	45	60	5	25	45	60	°		
2.0																						2.0		
3.0	3.20																					3.0		
3.5	3.20																					3.5		
4.0	3.20																					4.0		
4.5	3.20																					4.5		
5.0	3.20																					5.0		
5.5	3.20																					5.5		
6.0	3.20					3.20				3.00										2.90		6.0		
6.5	3.20					3.20				3.00				3.00						2.90		6.5		
7.0	3.20					3.20				3.00				3.00						2.90		7.0		
8.0	3.05	2.35				3.20				3.00				3.00						2.90		8.0		
9.0	2.75	2.20				3.20				3.00				3.00						2.90		9.0		
10.0	2.55	2.05				3.20				3.00				3.00						2.90		10.0		
11.0	2.35	1.90				3.20				3.00				3.00						2.90		11.0		
12.0	2.15	1.80	1.55			3.20	2.20			3.00	2.20			3.00	2.25					2.90	2.20	12.0		
13.0	2.00	1.70	1.50	0.90		3.10	2.15			3.00	2.15			3.00	2.15					2.90	2.15	13.0		
14.0	1.85	1.65	1.45	0.90		2.95	2.10			2.95	2.10			3.00	2.10					2.90	2.10	14.0		
16.0	1.65	1.50	1.35	0.85		2.70	1.95	1.50		2.70	1.95	1.50		2.80	2.00	1.50				2.80	2.00	1.50	16.0	
18.0	1.50	1.40	1.30			2.55	1.85	1.40	0.85	2.50	1.85	1.40	0.85	2.60	1.90	1.45	0.85			2.60	1.90	1.45	0.85	18.0
20.0	1.35	1.30				2.35	1.75	1.35	0.85	2.35	1.75	1.35	0.80	2.40	1.80	1.35	0.85			2.40	1.80	1.35	0.85	20.0
22.0						2.20	1.65	1.25	0.80	2.20	1.65	1.25	0.80	2.30	1.70	1.30	0.80			2.25	1.70	1.30	0.80	22.0
24.0						2.10	1.60	1.20	0.80	1.95	1.60	1.20	0.80	2.15	1.65	1.20	0.80			2.10	1.65	1.20	0.80	24.0
26.0						1.80	1.50	1.15	0.80	1.70	1.50	1.15	0.80	1.80	1.55	1.15	0.80			1.90	1.55	1.15	0.80	26.0
28.0						1.35	1.45	1.10	0.80	1.50	1.45	1.10	0.80	1.35	1.50	1.10	0.75			1.65	1.50	1.10	0.75	28.0
30.0						1.00	1.35	1.05		1.35	1.35	1.05		1.00	1.35	1.05	0.75			1.25	1.40	1.05	0.75	30.0
32.0						0.70	0.95	1.00		1.20	1.20	1.00		0.70	1.00	1.00				0.95	1.25	1.00		32.0
34.0						0.40	0.65	0.80		1.00	1.05	0.95		0.40	0.70	0.85				0.70	0.95	1.00		34.0
36.0										0.75	0.90				0.40	0.55				0.45	0.65	0.75		36.0
38.0										0.55	0.65										0.40	0.50		38.0
40.0											0.45													40.0
42.0																								42.0
1	0	0	0	0	0	100	100	100	100	0	0	0	0	100	100	100	100	50	50	50	50	1		
2	0	0	0	0	0	68	68	68	68	100	100	100	100	83	83	83	83	100	100	100	100	2		
3	0	0	0	0	0	68	68	68	68	100	100	100	100	100	83	83	83	83	100	100	100	100	3	
4	0	0	0	0	0	68	68	68	68	100	100	100	100	100	83	83	83	83	100	100	100	100	4	
MODE		1.2				1				2				1				2				MODE		
[DEG]		23~83.5	35~83.5	54~83.5	67~83.5	45~83.5	46~83.5	53~83.5	64~83.5	37~83.5	38~83.5	53~83.5	65~83.5	50~83.5	52~83.5	54~83.5	64~83.5	46~83.5	49~83.5	51~83.5	64~83.5	[DEG]		

m		40.0	40.0	40.0	40.0	40.0	40.0	40.0	40.0	41.2	41.2	41.2	41.2									m	
°		5	25	45	60	5	25	45	60	5	25	45	60									°	
2.0																						2.0	
3.0																						3.0	
3.5																						3.5	
4.0																						4.0	
4.5																						4.5	
5.0																						5.0	
5.5																						5.5	
6.0																						6.0	
6.5																						6.5	
7.0	3.00					2.80				2.50												7.0	
8.0	3.00					2.80				2.50												8.0	
9.0	3.00					2.80				2.50												9.0	
10.0	3.00					2.80				2.50												10.0	
11.0	3.00					2.80				2.50												11.0	
12.0	3.00					2.80				2.50												12.0	
13.0	3.00	2.15				2.80	2.15			2.50	2.15											13.0	
14.0	3.00	2.10				2.80	2.10			2.50	2.10											14.0	
16.0	2.85	2.00				2.80	2.00			2.50	2.00											16.0	
18.0	2.65	1.90	1.45	0.85		2.65	1.90	1.45	0.85	2.50	1.90	1.45	0.85									18.0	
20.0	2.45	1.80	1.40	0.85		2.45	1.80	1.40	0.85	2.50	1.80	1.40	0.85									20.0	
22.0	2.30	1.75	1.30	0.80		2.30	1.75	1.30	0.80	2.35	1.75	1.30	0.80									22.0	
24.0	2.20	1.65	1.25	0.80		2.20	1.65	1.25	0.80	2.20	1.65	1.25	0.80									24.0	
26.0	1.80	1.60	1.20	0.80		1.85	1.60	1.20	0.75	1.75	1.60	1.20	0.75									26.0	
28.0	1.35	1.50	1.10	0.75		1.45	1.50	1.10	0.75	1.35	1.55	1.15	0.75									28.0	
30.0	1.00	1.35	1.05	0.75		1.05	1.40	1.05	0.75	1.00	1.35	1.10	0.75									30.0	
32.0	0.70	1.00	1.05			0.75	1.05	1.05		0.70	1.00	1.05	0.75									32.0	
34.0	0.40	0.70	0.90			0.50	0.75	0.95		0.40	0.70	0.90										34.0	
36.0		0.45	0.55				0.50	0.65			0.45	0.60										36.0	
38.0																						38.0	
40.0																						40.0	
42.0																						42.0	
1	100	100	100	100		84	84	84	84	100	100	100	100									1	
2	95	95	95	95		100	100	100	100	100	100	100	100									2	
3	95	95	95	95		100	100	100	100	100	100	100	100									3	
4	95	95	95	95		100	100	100	100	100	100	100	100									4	
MODE		1				2				1.2													MODE
[DEG]		63~83.5	55~83.5	58~83.5	67~83.5	53~83.5	55~83.5	58~83.5	61~83.5	54~83.5	56~83.5	59~83.5	65~83.5									[DEG]	

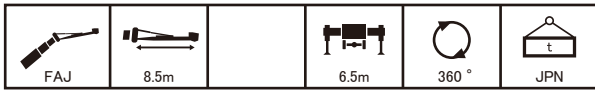

m		10.3	10.3	10.3	10.3	33.6	33.6	33.6	33.6	33.6	33.6	33.6	33.6	37.3	37.3	37.3	37.3	37.3	37.3	37.3	37.3	m	
°		5	25	45	60	5	25	45	60	5	25	45	60	5	25	45	60	5	25	45	60	°	
2.0	4.20																						2.0
3.0	4.20																						3.0
3.5	4.20																						3.5
4.0	4.20																						4.0
4.5	4.20	4.20				4.20																	4.5
5.0	4.20	4.20				4.20				4.20													5.0
5.5	4.20	4.20				4.20				4.20				4.20						4.20			5.5
6.0	4.20	4.20				4.20				4.20				4.20					4.20				6.0
6.5	4.20	4.20	3.00			4.20				4.20				4.20					4.20				6.5
7.0	4.20	4.20	2.90			4.20				4.20				4.20					4.20				7.0
8.0	4.20	3.95	2.75	1.70		4.20	4.20			4.20	4.20			4.20					4.20				8.0
9.0	4.20	3.75	2.60	1.65		4.20	4.20			4.20	4.20			4.20	4.20				4.20	4.20			9.0
10.0	4.20	3.50	2.50	1.60		4.20	4.20	2.85		4.20	4.20			4.20	4.20				4.20	4.20			10.0
11.0	3.95	3.30	2.45	1.60		4.20	4.20	2.75	1.65	4.20	4.10	2.75	1.65	4.20	4.20	2.80			4.20	4.20	2.75		11.0
12.0	3.70	3.15	2.35			4.20	4.00	2.70	1.65	4.20	3.85	2.70	1.65	4.20	4.10	2.70	1.65		4.20	4.00	2.70	1.65	12.0
13.0	3.45	3.00	2.35			4.20	3.85	2.65	1.60	4.20	3.65	2.65	1.60	4.20	3.95	2.65	1.60		4.20	3.75	2.65	1.60	13.0
14.0	3.25	2.90				4.20	3.70	2.60	1.60	4.05	3.45	2.60	1.60	4.20	3.80	2.60	1.60		4.20	3.60	2.60	1.60	14.0
16.0						4.20	3.45	2.45	1.55	3.50	3.10	2.45	1.55	4.15	3.55	2.50	1.55		4.20	3.25	2.50	1.55	16.0
18.0						3.25	3.20	2.35	1.55	3.00	2.80	2.35	1.55	3.20	3.30	2.40	1.55		3.45	2.95	2.40	1.55	18.0
20.0						2.45	2.85	2.25	1.50	2.65	2.50	2.25	1.50	2.40	2.85	2.30	1.50		2.80	2.70	2.30	1.50	20.0
22.0						1.80	2.15	2.15	1.50	2.30	2.20	2.15	1.50	1.80	2.15	2.20	1.50		2.15	2.40	2.20	1.50	22.0
24.0						1.25	1.55	1.75		1.90	1.95	1.90		1.30	1.60	1.85	1.50		1.60	1.90	2.05	1.45	24.0
26.0						0.85	1.10	1.25		1.50	1.70	1.70		0.85	1.15	1.30			1.15	1.40	1.55		26.0
28.0						0.45	0.65	0.80		1.10	1.25	1.35		0.50	0.70	0.85			0.80	1.00	1.15		28.0
30.0										0.80	0.95				0.40	0.50			0.50	0.65	0.75		30.0
32.0										0.50	0.60										0.45		32.0
34.0																							34.0
36.0																							36.0
38.0																							38.0
40.0																							40.0
42.0																							42.0
1	0	0	0	0		100	100	100	100		0	0	0	0	100	100	100	100	50	50	50	50	1
2	0	0	0	0		68	68	68	68		100	100	100	100	83	83	83	83	100	100	100	100	2
3	0	0	0	0		68	68	68	68		100	100	100	100	83	83	83	83	100	100	100	100	3
4	0	0	0	0		68	68	68	68		100	100	100	100	83	83	83	83	100	100	100	100	4
MODE		1,2				1				2				1				2				MODE	
[DEG]		30~83.5	38~83.5	49~83.5	63~83.5	47~83.5	50~83.5	52~83.5	64~83.5	38~83.5	42~83.5	53~83.5	65~83.5	52~83.5	52~83.5	54~83.5	64~83.5	48~83.5	52~83.5	50~83.5	64~83.5	[DEG]	

m		40.0	40.0	40.0	40.0	40.0	40.0	40.0	40.0	41.2	41.2	41.2	41.2										m	
°		5	25	45	60	5	25	45	60	5	25	45	60										°	
2.0																							2.0	
3.0																							3.0	
3.5																							3.5	
4.0																							4.0	
4.5																							4.5	
5.0																							5.0	
5.5																							5.5	
6.0	4.00					4.00				3.80													6.0	
6.5	4.00					4.00				3.80													6.5	
7.0	4.00					4.00				3.80													7.0	
8.0	4.00					4.00				3.80													8.0	
9.0	4.00					4.00				3.80													9.0	
10.0	4.00	4.00				4.00	4.00			3.80	3.80												10.0	
11.0	4.00	4.00				4.00	4.00			3.80	3.80												11.0	
12.0	4.00	4.00	2.70	1.65		4.00	4.00	2.70	1.65	3.80	3.80	2.75											12.0	
13.0	4.00	4.00	2.65	1.60		4.00	3.85	2.65	1.60	3.80	3.80	2.65	1.60										13.0	
14.0	4.00	3.85	2.60	1.60		4.00	3.65	2.60	1.60	3.80	3.70	2.60	1.60										14.0	
16.0	4.00	3.60	2.50	1.55		3.95	3.30	2.50	1.55	3.80	3.35	2.50	1.55										16.0	
18.0	3.15	3.35	2.40	1.55		3.25	3.05	2.40	1.55	3.15	3.05	2.40	1.55										18.0	
20.0	2.40	2.80	2.30	1.50		2.50	2.80	2.30	1.50	2.40	2.80	2.30	1.50										20.0	
22.0	1.80	2.15	2.20	1.50		1.90	2.25	2.20	1.50	1.75	2.15	2.20	1.50										22.0	
24.0	1.30	1.60	1.85	1.45		1.40	1.70	1.95	1.45	1.25	1.60	1.85	1.45										24.0	
26.0	0.85	1.15	1.35			0.95	1.25	1.40		0.85	1.15	1.35	1.40										26.0	
28.0	0.50	0.75	0.90			0.60	0.85	1.00		0.50	0.75	0.90											28.0	
30.0		0.40	0.50				0.50	0.60			0.40	0.50											30.0	
32.0																							32.0	
34.0																							34.0	
36.0																							36.0	
38.0																							38.0	
40.0																							40.0	
42.0																							42.0	
1	100	100	100	100		84	84	84	84	100	100	100	100										1	
2	95	95	95	95		100	100	100	100	100	100	100	100										2	
3	95	95	95	95		100	100	100	100	100	100	100	100										3	
4	95	95	95	95		100	100	100	100	100	100	100	100										4	
MODE		1				2				1,2														MODE
[DEG]		55~83.5	55~83.5	57~83.5	67~83.5	54~83.5	55~83.5	57~83.5	67~83.5	56~83.5	56~83.5	58~83.5	64~83.5										[DEG]	

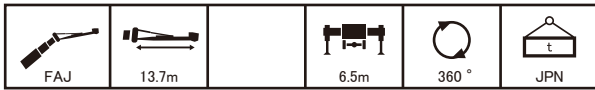

m		10.3	10.3	10.3	10.3	33.6	33.6	33.6	33.6	33.6	33.6	33.6	33.6	37.3	37.3	37.3	37.3	37.3	37.3	37.3	37.3	m		
°		5	25	45	60	5	25	45	60	5	25	45	60	5	25	45	60	5	25	45	60	°		
2.0																							2.0	
3.0	3.20																						3.0	
3.5	3.20																						3.5	
4.0	3.20																						4.0	
4.5	3.20																						4.5	
5.0	3.20																						5.0	
5.5	3.20																						5.5	
6.0	3.20					3.20				3.00													6.0	
6.5	3.20					3.20				3.00				3.00								2.90	6.5	
7.0	3.20					3.20				3.00				3.00								2.90	7.0	
8.0	3.05	2.35				3.20				3.00				3.00								2.90	8.0	
9.0	2.75	2.20				3.20				3.00				3.00								2.90	9.0	
10.0	2.55	2.05				3.20				3.00				3.00								2.90	10.0	
11.0	2.35	1.90				3.20				3.00				3.00								2.90	11.0	
12.0	2.15	1.80	1.55			3.20	2.20			3.00	2.20			3.00	2.25							2.90	12.0	
13.0	2.00	1.70	1.50	0.90		3.10	2.15			3.00	2.15			3.00	2.15							2.90	13.0	
14.0	1.85	1.65	1.45	0.90		2.95	2.10			2.95	2.10			3.00	2.10							2.90	14.0	
16.0	1.65	1.50	1.35	0.85		2.70	1.95	1.50		2.70	1.95	1.50		2.80	2.00	1.50						2.80	16.0	
18.0	1.50	1.40	1.30			2.55	1.85	1.40	0.85	2.50	1.85	1.40	0.85	2.60	1.90	1.45	0.85					2.80	18.0	
20.0	1.35	1.30				2.35	1.75	1.35	0.85	2.35	1.75	1.35	0.80	2.40	1.80	1.35	0.85					2.40	20.0	
22.0						2.20	1.65	1.25	0.80	2.20	1.65	1.25	0.80	2.25	1.70	1.30	0.80					2.25	22.0	
24.0						1.75	1.60	1.20	0.80	1.95	1.60	1.20	0.80	1.75	1.65	1.20	0.80					2.05	24.0	
26.0						1.30	1.50	1.15	0.80	1.70	1.50	1.15	0.80	1.30	1.55	1.15	0.80					1.60	26.0	
28.0						0.95	1.30	1.10	0.80	1.50	1.45	1.10	0.80	0.95	1.30	1.10	0.75					1.20	28.0	
30.0						0.60	0.95	1.05		1.15	1.35	1.05		0.60	0.95	1.05	0.75					0.90	30.0	
32.0							0.60	0.80		0.90	1.10	1.00			0.65	0.85						0.60	32.0	
34.0								0.45		0.65	0.85	0.95				0.50						0.60	34.0	
36.0										0.45	0.60											0.45	36.0	
38.0																							38.0	
40.0																							40.0	
42.0																							42.0	
1	0	0	0	0		100	100	100	100	0	0	0	0	100	100	100	100	50	50	50	50	1	1	
2	0	0	0	0		68	68	68	68	100	100	100	100	83	83	83	83	100	100	100	100	2	2	
3	0	0	0	0		68	68	68	68	100	100	100	100	100	83	83	83	83	100	100	100	100	3	3
4	0	0	0	0		68	68	68	68	100	100	100	100	100	83	83	83	83	100	100	100	100	4	4
MODE		1,2				1				2				1				2				MODE		
[DEG]		23~83.5	35~83.5	54~83.5	67~83.5	51~83.5	54~83.5	53~83.5	64~83.5	41~83.5	47~83.5	53~83.5	65~83.5	55~83.5	58~83.5	58~83.5	64~83.5	53~83.5	55~83.5	55~83.5	64~83.5	[DEG]		

m		40.0	40.0	40.0	40.0	40.0	40.0	40.0	40.0	41.2	41.2	41.2	41.2										m
°		5	25	45	60	5	25	45	60	5	25	45	60										°
2.0																							2.0
3.0																							3.0
3.5																							3.5
4.0																							4.0
4.5																							4.5
5.0																							5.0
5.5																							5.5
6.0																							6.0
6.5																							6.5
7.0	3.00					2.80				2.50													7.0
8.0	3.00					2.80				2.50													8.0
9.0	3.00					2.80				2.50													9.0
10.0	3.00					2.80				2.50													10.0
11.0	3.00					2.80				2.50													11.0
12.0	3.00					2.80				2.50													12.0
13.0	3.00	2.15				2.80	2.15			2.50	2.15												13.0
14.0	3.00	2.10				2.80	2.10			2.50	2.10												14.0
16.0	2.85	2.00				2.80	2.00			2.50	2.00												16.0
18.0	2.65	1.90	1.45	0.85		2.65	1.90	1.45	0.85	2.50	1.90	1.45	0.85										18.0
20.0	2.45	1.80	1.40	0.85		2.45	1.80	1.40	0.85	2.50	1.80	1.40	0.85										20.0
22.0	2.20	1.75	1.30	0.80		2.30	1.75	1.30	0.80	2.20	1.75	1.30	0.80										22.0
24.0	1.70	1.65	1.25	0.80		1.80	1.65	1.25	0.80	1.70	1.65	1.25	0.80										24.0
26.0	1.25	1.60	1.20	0.80		1.35	1.60	1.20	0.75	1.25	1.60	1.20	0.75										26.0
28.0	0.90	1.30	1.10	0.75		1.00	1.40	1.10	0.75	0.90	1.30	1.15	0.75										28.0
30.0	0.60	0.95	1.05	0.75		0.70	1.05	1.05	0.75	0.60	0.95	1.10	0.75										30.0
32.0		0.65	0.85			0.40	0.70	0.90			0.65	0.85	0.75										32.0
34.0			0.55				0.45	0.60				0.55											34.0
36.0																							36.0
38.0																							38.0
40.0																							40.0
42.0																							42.0
1	100	100	100	100		84	84	84	84	100	100	100	100										1
2	95	95	95	95		100	100	100	100	100	100	100	100										2
3	95	95	95	95		100	100	100	100	100	100	100	100										3
4	95	95	95	95		100	100	100	100	100	100	100	100										4
MODE		1				2				1,2								MODE					
[DEG]		58~83.5	60~83.5	60~83.5	67~83.5	55~83.5	58~83.5	61~83.5	67~83.5	59~83.5	61~83.5	62~83.5	65~83.5										[DEG]

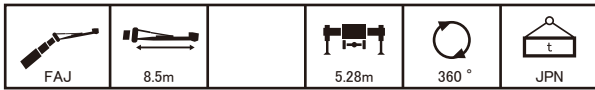

m		10.3	10.3	10.3	10.3	33.6	33.6	33.6	33.6	33.6	33.6	33.6	33.6	37.3	37.3	37.3	37.3	37.3	37.3	37.3	37.3	m			
°		5	25	45	60	5	25	45	60	5	25	45	60	5	25	45	60	5	25	45	60	°			
2.0	4.20																						2.0		
3.0	4.20																						3.0		
3.5	4.20																						3.5		
4.0	4.20																						4.0		
4.5	4.20	4.20				4.20																	4.5		
5.0	4.20	4.20				4.20				4.20													5.0		
5.5	4.20	4.20				4.20				4.20				4.20							4.20		5.5		
6.0	4.20	4.20				4.20				4.20				4.20							4.20		6.0		
6.5	4.20	4.20	3.00			4.20				4.20				4.20							4.20		6.5		
7.0	4.20	4.20	2.90			4.20				4.20				4.20							4.20		7.0		
8.0	4.20	3.95	2.75	1.70		4.20	4.20			4.20	4.20			4.20							4.20		8.0		
9.0	4.20	3.75	2.60	1.65		4.20	4.20			4.20	4.20			4.20	4.20						4.20	4.20	9.0		
10.0	4.20	3.50	2.50	1.60		4.20	4.20	2.85		4.20	4.20			4.20	4.20						4.20	4.20	10.0		
11.0	3.95	3.30	2.45	1.60		4.20	4.20	2.75	1.65	4.20	4.10	2.75	1.65	4.20	4.20	2.80					4.20	4.20	2.75	11.0	
12.0	3.70	3.15	2.35			4.20	4.00	2.70	1.65	4.20	3.85	2.70	1.65	4.20	4.10	2.70	1.65				4.20	4.00	2.70	1.65	12.0
13.0	3.45	3.00	2.35			4.20	3.85	2.65	1.60	4.20	3.65	2.65	1.60	4.20	3.95	2.65	1.60				4.20	3.75	2.65	1.60	13.0
14.0	3.25	2.90				3.65	3.70	2.60	1.60	4.05	3.45	2.60	1.60	3.60	3.80	2.60	1.60				4.00	3.60	2.60	1.60	14.0
16.0						2.65	3.20	2.45	1.55	3.45	3.10	2.45	1.55	2.60	3.15	2.50	1.55				3.00	3.25	2.50	1.55	16.0
18.0						1.90	2.35	2.35	1.55	2.65	2.80	2.35	1.55	1.85	2.35	2.40	1.55				2.20	2.65	2.40	1.55	18.0
20.0						1.25	1.65	1.95	1.50	2.00	2.30	2.25	1.50	1.25	1.65	1.95	1.50				1.60	2.00	2.25	1.50	20.0
22.0						0.75	1.10	1.35	1.45	1.50	1.75	1.95	1.50	0.75	1.10	1.35	1.45				1.10	1.45	1.65	1.50	22.0
24.0							0.65	0.85		1.05	1.30	1.45			0.65	0.85	0.95				0.70	0.95	1.15	1.25	24.0
26.0								0.40		0.70	0.90	1.00				0.45						0.60	0.75		26.0
28.0										0.40	0.55	0.65											0.40		28.0
30.0																									30.0
32.0																									32.0
34.0																									34.0
36.0																									36.0
38.0																									38.0
40.0																									40.0
42.0																									42.0
1	0	0	0	0		100	100	100	100		0	0	0	0	100	100	100	100			50	50	50	50	1
2	0	0	0	0		68	68	68	68		100	100	100	100	83	83	83	83			100	100	100	100	2
3	0	0	0	0		68	68	68	68		100	100	100	100	83	83	83	83			100	100	100	100	3
4	0	0	0	0		68	68	68	68		100	100	100	100	83	83	83	83			100	100	100	100	4
MODE		1,2				1				2				1				2				MODE			
[DEG]		30~83.5	38~83.5	49~83.5	63~83.5	58~83.5	58~83.5	56~83.5	64~83.5	47~83.5	51~83.5	53~83.5	65~83.5	61~83.5	61~83.5	60~83.5	64~83.5	58~83.5	58~83.5	57~83.5	64~83.5			[DEG]	

m		40.0	40.0	40.0	40.0	40.0	40.0	40.0	40.0	41.2	41.2	41.2	41.2											m	
°		5	25	45	60	5	25	45	60	5	25	45	60											°	
2.0																								2.0	
3.0																								3.0	
3.5																								3.5	
4.0																								4.0	
4.5																								4.5	
5.0																								5.0	
5.5																								5.5	
6.0	4.00					4.00				3.80														6.0	
6.5	4.00					4.00				3.80														6.5	
7.0	4.00					4.00				3.80														7.0	
8.0	4.00					4.00				3.80														8.0	
9.0	4.00					4.00				3.80														9.0	
10.0	4.00	4.00				4.00	4.00			3.80	3.80													10.0	
11.0	4.00	4.00				4.00	4.00			3.80	3.80													11.0	
12.0	4.00	4.00	2.70	1.65		4.00	4.00	2.70	1.65	3.80	3.80	2.75												12.0	
13.0	4.00	4.00	2.65	1.60		4.00	3.85	2.65	1.60	3.80	3.80	2.65	1.60											13.0	
14.0	3.55	3.85	2.60	1.60		3.65	3.65	2.60	1.60	3.50	3.70	2.60	1.60											14.0	
16.0	2.60	3.15	2.50	1.55		2.70	3.25	2.50	1.55	2.55	3.10	2.50	1.55											16.0	
18.0	1.85	2.30	2.40	1.55		1.95	2.40	2.40	1.55	1.80	2.30	2.40	1.55											18.0	
20.0	1.25	1.65	1.95	1.50		1.35	1.75	2.05	1.50	1.20	1.65	1.95	1.50											20.0	
22.0	0.75	1.10	1.35	1.50		0.85	1.20	1.45	1.50	0.75	1.10	1.35	1.50											22.0	
24.0		0.65	0.85	0.95		0.45	0.75	0.95	1.05		0.65	0.90	0.95											24.0	
26.0			0.45					0.55				0.45												26.0	
28.0																								28.0	
30.0																								30.0	
32.0																								32.0	
34.0																								34.0	
36.0																								36.0	
38.0																								38.0	
40.0																								40.0	
42.0																								42.0	
1	100	100	100	100		84	84	84	84	100	100	100	100											1	
2	95	95	95	95		100	100	100	100	100	100	100	100											2	
3	95	95	95	95		100	100	100	100	100	100	100	100											3	
4	95	95	95	95		100	100	100	100	100	100	100	100											4	
MODE		1				2				1,2															MODE
[DEG]		64~83.5	63~83.5	63~83.5	67~83.5	59~83.5	64~83.5	63~83.5	67~83.5	64~83.5	64~83.5	64~83.5	67~83.5											[DEG]	

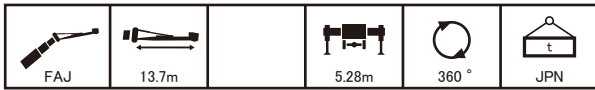

m		10.3	10.3	10.3	10.3	33.6	33.6	33.6	33.6	33.6	33.6	33.6	33.6	37.3	37.3	37.3	37.3	37.3	37.3	37.3	37.3	m	
°		5	25	45	60	5	25	45	60	5	25	45	60	5	25	45	60	5	25	45	60	°	
2.0																						2.0	
3.0	3.20																					3.0	
3.5	3.20																					3.5	
4.0	3.20																					4.0	
4.5	3.20																					4.5	
5.0	3.20																					5.0	
5.5	3.20																					5.5	
6.0	3.20					3.20				3.00												6.0	
6.5	3.20					3.20				3.00				3.00						2.90		6.5	
7.0	3.20					3.20				3.00				3.00						2.90		7.0	
8.0	3.05	2.35				3.20				3.00				3.00						2.90		8.0	
9.0	2.75	2.20				3.20				3.00				3.00						2.90		9.0	
10.0	2.55	2.05				3.20				3.00				3.00						2.90		10.0	
11.0	2.35	1.90				3.20				3.00				3.00						2.90		11.0	
12.0	2.15	1.80	1.55			3.20	2.20			3.00	2.20			3.00	2.25				2.90	2.20		12.0	
13.0	2.00	1.70	1.50	0.90		3.10	2.15			3.00	2.15			3.00	2.15				2.90	2.15		13.0	
14.0	1.85	1.65	1.45	0.90		2.95	2.10			2.95	2.10			3.00	2.10				2.90	2.10		14.0	
16.0	1.65	1.50	1.35	0.85		2.70	1.95	1.50		2.70	1.95	1.50		2.80	2.00	1.50			2.80	2.00	1.50	16.0	
18.0	1.50	1.40	1.30			2.35	1.85	1.40	0.85	2.50	1.85	1.40	0.85	2.30	1.90	1.45	0.85		2.60	1.90	1.45	0.85	18.0
20.0	1.35	1.30				1.75	1.75	1.35	0.85	2.35	1.75	1.35	0.80	1.70	1.80	1.35	0.85		2.00	1.80	1.35	0.85	20.0
22.0						1.25	1.65	1.25	0.80	1.90	1.65	1.25	0.80	1.20	1.70	1.30	0.80		1.50	1.70	1.30	0.80	22.0
24.0						0.85	1.30	1.20	0.80	1.45	1.60	1.20	0.80	0.80	1.30	1.20	0.80		1.10	1.55	1.20	0.80	24.0
26.0						0.45	0.90	1.15	0.80	1.10	1.40	1.15	0.80	0.45	0.90	1.15	0.80		0.75	1.15	1.15	0.80	26.0
28.0							0.55	0.80	0.80	0.75	1.05	1.10	0.80		0.55	0.80	0.75		0.45	0.80	1.05	0.75	28.0
30.0								0.45		0.50	0.75	0.95				0.45	0.55			0.50	0.70	0.75	30.0
32.0											0.50	0.65									0.40		32.0
34.0																							34.0
36.0																							36.0
38.0																							38.0
40.0																							40.0
42.0																							42.0
1	0	0	0	0		100	100	100	100	0	0	0	0	100	100	100	100		50	50	50	50	1
2	0	0	0	0		68	68	68	68	100	100	100	100	83	83	83	83		100	100	100	100	2
3	0	0	0	0		68	68	68	68	100	100	100	100	100	83	83	83		100	100	100	100	3
4	0	0	0	0		68	68	68	68	100	100	100	100	100	83	83	83		100	100	100	100	4
MODE		1,2				1				2				1				2				MODE	
[DEG]		23~83.5	35~83.5	54~83.5	67~83.5	57~83.5	60~83.5	60~83.5	64~83.5	52~83.5	54~83.5	57~83.5	65~83.5	61~83.5	63~83.5	64~83.5	64~83.5		58~83.5	61~83.5	61~83.5	64~83.5	[DEG]

m		40.0	40.0	40.0	40.0	40.0	40.0	40.0	40.0	41.2	41.2	41.2	41.2									m	
°		5	25	45	60	5	25	45	60	5	25	45	60									°	
2.0																						2.0	
3.0																						3.0	
3.5																						3.5	
4.0																						4.0	
4.5																						4.5	
5.0																						5.0	
5.5																						5.5	
6.0																						6.0	
6.5																						6.5	
7.0	3.00					2.80				2.50												7.0	
8.0	3.00					2.80				2.50												8.0	
9.0	3.00					2.80				2.50												9.0	
10.0	3.00					2.80				2.50												10.0	
11.0	3.00					2.80				2.50												11.0	
12.0	3.00					2.80				2.50												12.0	
13.0	3.00	2.15				2.80	2.15			2.50	2.15											13.0	
14.0	3.00	2.10				2.80	2.10			2.50	2.10											14.0	
16.0	2.85	2.00				2.80	2.00			2.50	2.00											16.0	
18.0	2.25	1.90	1.45	0.85		2.35	1.90	1.45	0.85	2.25	1.90	1.45	0.85									18.0	
20.0	1.65	1.80	1.40	0.85		1.75	1.80	1.40	0.85	1.65	1.80	1.40	0.85									20.0	
22.0	1.15	1.75	1.30	0.80		1.25	1.75	1.30	0.80	1.15	1.75	1.30	0.80									22.0	
24.0	0.75	1.25	1.25	0.80		0.85	1.35	1.25	0.80	0.75	1.25	1.25	0.80									24.0	
26.0	0.40	0.85	1.20	0.80		0.50	0.95	1.20	0.75	0.40	0.85	1.20	0.75									26.0	
28.0		0.50	0.80	0.75			0.60	0.90	0.75		0.50	0.80	0.75									28.0	
30.0			0.45	0.55				0.55	0.65			0.45	0.55									30.0	
32.0																						32.0	
34.0																						34.0	
36.0																						36.0	
38.0																						38.0	
40.0																						40.0	
42.0																						42.0	
1	100	100	100	100		84	84	84	84	100	100	100	100									1	
2	95	95	95	95		100	100	100	100	100	100	100	100									2	
3	95	95	95	95		100	100	100	100	100	100	100	100									3	
4	95	95	95	95		100	100	100	100	100	100	100	100									4	
MODE		1				2				1,2													MODE
[DEG]		63~83.5	65~83.5	65~83.5	67~83.5	63~83.5	65~83.5	66~83.5	67~83.5	64~83.5	66~83.5	67~83.5	68~83.5									[DEG]	

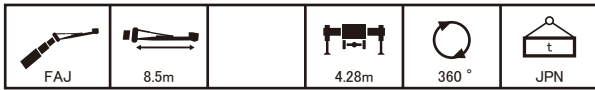

m		10.3	10.3	10.3	10.3	33.6	33.6	33.6	33.6	33.6	33.6	33.6	33.6	37.3	37.3	37.3	37.3	37.3	37.3	37.3	37.3	m			
°		5	25	45	60	5	25	45	60	5	25	45	60	5	25	45	60	5	25	45	60	°			
2.0	4.20																						2.0		
3.0	4.20																						3.0		
3.5	4.20																						3.5		
4.0	4.20																						4.0		
4.5	4.20	4.20				4.20																	4.5		
5.0	4.20	4.20				4.20				4.20													5.0		
5.5	4.20	4.20				4.20				4.20				4.20							4.20		5.5		
6.0	4.20	4.20				4.20				4.20				4.20							4.20		6.0		
6.5	4.20	4.20	3.00			4.20				4.20				4.20							4.20		6.5		
7.0	4.20	4.20	2.90			4.20				4.20				4.20							4.20		7.0		
8.0	4.20	3.95	2.75	1.70		4.20	4.20			4.20	4.20			4.20							4.20		8.0		
9.0	4.20	3.75	2.60	1.65		4.20	4.20			4.20	4.20			4.20	4.20						4.20	4.20	9.0		
10.0	4.20	3.50	2.50	1.60		4.20	4.20	2.85		4.20	4.20			4.20	4.20						4.20	4.20	10.0		
11.0	3.95	3.30	2.45	1.60		4.05	4.20	2.75	1.65	4.20	4.10	2.75	1.65	3.95	4.20	2.80					4.20	4.20	2.75	11.0	
12.0	3.70	3.15	2.35			3.35	4.00	2.70	1.65	4.15	3.85	2.70	1.65	3.25	4.05	2.70	1.65				3.65	4.00	2.70	1.65	12.0
13.0	3.45	3.00	2.35			2.75	3.45	2.65	1.60	3.55	3.65	2.65	1.60	2.70	3.40	2.65	1.60				3.10	3.70	2.65	1.60	13.0
14.0	3.25	2.90				2.30	2.90	2.60	1.60	3.05	3.45	2.60	1.60	2.25	2.85	2.60	1.60				2.60	3.20	2.60	1.60	14.0
16.0						1.50	2.00	2.45	1.55	2.25	2.65	2.45	1.55	1.45	2.00	2.40	1.55				1.80	2.30	2.50	1.55	16.0
18.0						0.85	1.30	1.65	1.55	1.60	1.95	2.25	1.55	0.85	1.30	1.65	1.55				1.20	1.60	1.95	1.55	18.0
20.0							0.75	1.05	1.15	1.10	1.40	1.65	1.50		0.75	1.05	1.15				0.70	1.05	1.35	1.45	20.0
22.0								0.50	0.60	0.65	0.95	1.15	1.20			0.55	0.65					0.60	0.85	0.90	22.0
24.0											0.55	0.70											0.40	0.45	24.0
26.0																									26.0
28.0																									28.0
30.0																									30.0
32.0																									32.0
34.0																									34.0
36.0																									36.0
38.0																									38.0
40.0																									40.0
42.0																									42.0
1	0	0	0	0		100	100	100	100		0	0	0	0	100	100	100	100			50	50	50	50	1
2	0	0	0	0		68	68	68	68		100	100	100	100	83	83	83	83			100	100	100	100	2
3	0	0	0	0		68	68	68	68		100	100	100	100	83	83	83	83			100	100	100	100	3
4	0	0	0	0		68	68	68	68		100	100	100	100	83	83	83	83			100	100	100	100	4
MODE		1,2				1				2				1				2				MODE			
[DEG]		30~83.5	38~83.5	49~83.5	63~83.5	65~83.5	64~83.5	63~83.5	64~83.5	58~83.5	58~83.5	60~83.5	65~83.5	67~83.5	67~83.5	66~83.5	67~83.5	64~83.5	64~83.5	64~83.5	64~83.5	[DEG]			

m		40.0	40.0	40.0	40.0	40.0	40.0	40.0	40.0	41.2	41.2	41.2	41.2										m	
°		5	25	45	60	5	25	45	60	5	25	45	60										°	
2.0																							2.0	
3.0																							3.0	
3.5																							3.5	
4.0																							4.0	
4.5																							4.5	
5.0																							5.0	
5.5																							5.5	
6.0	4.00					4.00				3.80													6.0	
6.5	4.00					4.00				3.80													6.5	
7.0	4.00					4.00				3.80													7.0	
8.0	4.00					4.00				3.80													8.0	
9.0	4.00					4.00				3.80													9.0	
10.0	4.00	4.00				4.00	4.00			3.80	3.80												10.0	
11.0	3.85	4.00				3.95	4.00			3.80	3.80												11.0	
12.0	3.20	3.95	2.70	1.65		3.30	4.00	2.70	1.65	3.20	3.80	2.75											12.0	
13.0	2.65	3.35	2.65	1.60		2.75	3.45	2.65	1.60	2.65	3.35	2.65	1.60										13.0	
14.0	2.20	2.85	2.60	1.60		2.30	2.90	2.60	1.60	2.20	2.80	2.60	1.60										14.0	
16.0	1.40	1.95	2.40	1.55		1.55	2.05	2.45	1.55	1.40	1.95	2.40	1.55										16.0	
18.0	0.80	1.30	1.65	1.55		0.90	1.35	1.75	1.55	0.80	1.25	1.65	1.55										18.0	
20.0		0.75	1.05	1.20		0.45	0.85	1.15	1.25		0.75	1.05	1.20										20.0	
22.0			0.55	0.65				0.65	0.75			0.55	0.65										22.0	
24.0																							24.0	
26.0																							26.0	
28.0																							28.0	
30.0																							30.0	
32.0																							32.0	
34.0																							34.0	
36.0																							36.0	
38.0																							38.0	
40.0																							40.0	
42.0																							42.0	
1	100	100	100	100		84	84	84	84	100	100	100	100										1	
2	95	95	95	95		100	100	100	100	100	100	100	100										2	
3	95	95	95	95		100	100	100	100	100	100	100	100										3	
4	95	95	95	95		100	100	100	100	100	100	100	100										4	
MODE		1				2				1,2														MODE
[DEG]		69~83.5	69~83.5	68~83.5	69~83.5	65~83.5	69~83.5	68~83.5	69~83.5	69~83.5	69~83.5	69~83.5	70~83.5										[DEG]	

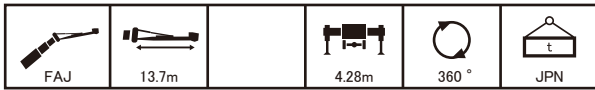







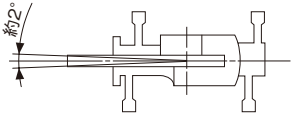





m	10.3	10.3	10.3	10.3	33.6	33.6	33.6	33.6	33.6	33.6	33.6	33.6	37.3	37.3	37.3	37.3	37.3	37.3	37.3	37.3	m	
°	5	25	45	60	5	25	45	60	5	25	45	60	5	25	45	60	5	25	45	60	°	
2.0																					2.0	
3.0	3.20																				3.0	
3.5	3.20																				3.5	
4.0	3.20																				4.0	
4.5	3.20																				4.5	
5.0	3.20																				5.0	
5.5	3.20																				5.5	
6.0	3.20				3.20				3.00												6.0	
6.5	3.20				3.20				3.00				3.00				2.90				6.5	
7.0	3.20				3.20				3.00				3.00				2.90				7.0	
8.0	3.05	2.35			3.20				3.00				3.00				2.90				8.0	
9.0	2.75	2.20			3.20				3.00				3.00				2.90				9.0	
10.0	2.55	2.05			3.20				3.00				3.00				2.90				10.0	
11.0	2.35	1.90			3.20				3.00				3.00				2.90				11.0	
12.0	2.15	1.80	1.55		3.20	2.20			3.00	2.20			3.00	2.25			2.90	2.20			12.0	
13.0	2.00	1.70	1.50	0.90	3.10	2.15			3.00	2.15			3.00	2.15			2.90	2.15			13.0	
14.0	1.85	1.65	1.45	0.90	2.75	2.10			2.95	2.10			2.70	2.10			2.90	2.10			14.0	
16.0	1.65	1.50	1.35	0.85	1.95	1.95	1.50		2.60	1.95	1.50		1.90	2.00	1.50		2.20	2.00	1.50		16.0	
18.0	1.50	1.40	1.30		1.35	1.85	1.40	0.85	2.00	1.85	1.40	0.85	1.30	1.90	1.45	0.85	1.60	1.90	1.45	0.85	18.0	
20.0	1.35	1.30			0.85	1.45	1.35	0.85	1.45	1.75	1.35	0.80	0.80	1.40	1.35	0.85	1.10	1.65	1.35	0.85	20.0	
22.0					0.40	0.95	1.25	0.80	1.05	1.50	1.25	0.80		0.95	1.30	0.80	0.70	1.20	1.30	0.80	22.0	
24.0						0.55	0.95	0.80	0.70	1.10	1.20	0.80		0.55	0.90	0.80		0.80	1.15	0.80	24.0	
26.0							0.50	0.65	0.40	0.75	1.00	0.80			0.50	0.65		0.45	0.75	0.80	26.0	
28.0										0.45	0.65	0.75							0.40	0.50	0.80	28.0
30.0																					30.0	
32.0																					32.0	
34.0																					34.0	
36.0																					36.0	
38.0																					38.0	
40.0																					40.0	
42.0																					42.0	
1	0	0	0	0	100	100	100	100	0	0	0	0	100	100	100	100	50	50	50	50	1	
2	0	0	0	0	68	68	68	68	100	100	100	100	83	83	83	83	100	100	100	100	2	
3	0	0	0	0	68	68	68	68	100	100	100	100	100	83	83	83	83	100	100	100	100	3
4	0	0	0	0	68	68	68	68	100	100	100	100	100	83	83	83	83	100	100	100	100	4
MODE	1.2				1				2				1				2				MODE	
[DEG]	23~83.5	35~83.5	54~83.5	67~83.5	63~83.5	66~83.5	66~83.5	67~83.5	58~83.5	60~83.5	64~83.5	65~83.5	68~83.5	68~83.5	69~83.5	70~83.5	66~83.5	66~83.5	67~83.5	67~83.5	[DEG]	

m	40.0	40.0	40.0	40.0	40.0	40.0	40.0	40.0	41.2	41.2	41.2	41.2									m	
°	5	25	45	60	5	25	45	60	5	25	45	60									°	
2.0																					2.0	
3.0																					3.0	
3.5																					3.5	
4.0																					4.0	
4.5																					4.5	
5.0																					5.0	
5.5																					5.5	
6.0																					6.0	
6.5																					6.5	
7.0	3.00				2.80				2.50												7.0	
8.0	3.00				2.80				2.50												8.0	
9.0	3.00				2.80				2.50												9.0	
10.0	3.00				2.80				2.50												10.0	
11.0	3.00				2.80				2.50												11.0	
12.0	3.00				2.80				2.50												12.0	
13.0	3.00	2.15			2.80	2.15			2.50	2.15											13.0	
14.0	2.60	2.10			2.70	2.10			2.50	2.10											14.0	
16.0	1.85	2.00			1.95	2.00			1.85	2.00											16.0	
18.0	1.25	1.90	1.45	0.85	1.35	1.90	1.45	0.85	1.25	1.90	1.45	0.85									18.0	
20.0	0.75	1.40	1.40	0.85	0.85	1.45	1.40	0.85	0.75	1.40	1.40	0.85									20.0	
22.0		0.90	1.30	0.80	0.45	1.00	1.30	0.80		0.90	1.30	0.80									22.0	
24.0		0.50	0.90	0.80		0.60	1.00	0.80		0.50	0.90	0.80									24.0	
26.0			0.50	0.65			0.60	0.75			0.50	0.65									26.0	
28.0																					28.0	
30.0																					30.0	
32.0																					32.0	
34.0																					34.0	
36.0																					36.0	
38.0																					38.0	
40.0																					40.0	
42.0																					42.0	
1	100	100	100	100	84	84	84	84	100	100	100	100									1	
2	95	95	95	95	100	100	100	100	100	100	100	100									2	
3	95	95	95	95	100	100	100	100	100	100	100	100									3	
4	95	95	95	95	100	100	100	100	100	100	100	100									4	
MODE	1				2				1.2													MODE
[DEG]	69~83.5	70~83.5	70~83.5	72~83.5	68~83.5	70~83.5	71~83.5	72~83.5	71~83.5	70~83.5	71~83.5	73~83.5									[DEG]	



■ 定格総荷重表注意事項 【アウトリガ不使用時】



1. 定格総荷重は、水平堅土上においてタイヤのエア圧が規定圧(900kPa(9.00kgf/cm²))で、かつサスペンションシリンダを最縮小した場合の値で、ブーム作業時はつり具と主巻フック質量(35tフック:310kg)を含んだ値です。太線より上はクレーンの強度によって定められ、下は安定度によって定められています。実際の作業では、地盤、作業状態等を考慮して使用してください。
 2. 作業半径は、ブームおよびタイヤのたわみを含んだ実際の値に基づいていますので、必ず作業半径を基準にしてください。
 3. 各ブーム長さにおけるフックのワイヤロープ標準巻掛本数はアウトリガ不使用時の各定格総荷重表中に記載しています。ただし、この掛数以外で使用する場合は、ロープ1本当り主巻5.0t以下、補巻5.0t以下としてください。
 4. 「前方」のクレーン作業は、AMLの「前方位置シンボル」が点灯しているときに行ってください。前方の範囲は、ブームがキャリヤの前方2°以内です。
- 
5. シングルトップ使用時の標準巻掛本数は1本です。シングルトップの定格総荷重は、ブームの定格総荷重から210kgを差し引いた値とし、つり具と補巻フック質量(100kg)を含んだ値で、かつ限度は5.0tです。
 6. 高速巻き下げ作業、ブーム長さが17.8mを超えるブーム作業およびジブの使用はしないでください。
 7. つり荷走行は、「駆動モード切換えスイッチを[ローデブロック]にし、シフトスイッチを1速にして行ってください。
 8. つり荷走行は、旋回ブレーキをかけ、荷が振れないように地面近くに保持し、1.6km/h以下で行ってください。特に急ハンドル、急発進、急ブレーキは避けてください。
 9. つり荷走行中は、クレーン作業を行わないでください。



定格総荷重表中のシンボル、記号の説明



 MB	ブームの定格総荷重を示します。	 JPN	定格総荷重の単位を示します。
 アウトリガ不使用 静止	静止時を示します。	 m	ブーム長さを示します。
 アウトリガ不使用 走行(1.6km/h以下)	走行時(1.6km/h以下)を示します。	 m	作業半径を示します。
 360°	吊上げ可能な旋回範囲を示します。	 %	ブーム伸縮状態(伸縮割合%)を示します。MODEはブーム伸縮モードを示します。
 前方	前方の場合、前方限定を示します。		無負荷状態で作動可能なブーム起伏角度範囲を示します。
			標準巻掛本数を示します。
			標準フックを示します。

■ アウトリガ不使用時の定格総荷重表

MB	アウトリガ不使用 静止					前方	JPN
m	10.3	14.1	14.1	17.8	17.8		m
	3.0	6.80	6.60	7.30	6.40	7.60	3.0
	3.5	5.90	5.70	6.40	5.50	6.70	3.5
	4.0	5.10	4.90	5.70	4.80	6.00	4.0
	4.5	4.40	4.20	5.00	4.10	5.30	4.5
	5.0	3.90	3.70	4.50	3.50	4.80	5.0
	5.5	3.40	3.10	4.00	3.00	4.30	5.5
	6.0	2.90	2.70	3.50	2.50	3.80	6.0
	6.5	2.50	2.30	3.10	2.10	3.40	6.5
	7.0	2.10	1.90	2.70	1.80	3.10	7.0
	8.0		1.30	2.10	1.10	2.40	8.0
	9.0		0.75	1.60	0.60	1.90	9.0
	10.0			1.20		1.50	10.0
	11.0			0.80		1.10	11.0
	12.0					0.80	12.0
	1	0	50	0	100	0	1
	2	0	0	16	0	33	2
	3	0	0	16	0	33	3
	4	0	0	16	0	33	4
MODE	1,2	1	2	1	2		MODE
[DEG]	0~83.5	32~83.5	5~83.5	50~83.5	23~83.5		[DEG]
	4	4	4	4	4		
						35t	

MB	アウトリガ不使用 静止					360°	JPN
m	10.3	14.1	14.1	17.8	17.8		m
	3.0	5.10	4.80	5.90			3.0
	3.5	4.00	3.70	4.80	3.60	5.20	3.5
	4.0	3.10	2.90	3.90	2.70	4.40	4.0
	4.5	2.40	2.20	3.20	2.00	3.60	4.5
	5.0	1.80	1.60	2.60	1.40	3.00	5.0
	5.5	1.30	1.10	2.10	0.90	2.50	5.5
	6.0	0.90	0.65	1.60		2.10	6.0
	6.5	0.50		1.30		1.70	6.5
	7.0			0.95		1.30	7.0
	8.0					0.80	8.0
	9.0						9.0
	10.0						10.0
	11.0						11.0
	12.0						12.0
	1	0	50	0	100	0	1
	2	0	0	16	0	33	2
	3	0	0	16	0	33	3
	4	0	0	16	0	33	4
MODE	1,2	1	2	1	2		MODE
[DEG]	25~66	54~70	44~70	65~73	52~73		[DEG]
	4	4	4	4	4		
						35t	

MB	アウトリガ不使用 走行(1.6km/h以下)					前方	JPN
m	10.3	14.1	14.1	17.8	17.8		m
	3.0	5.70	5.60	6.20	5.50	6.50	3.0
	3.5	5.00	4.80	5.50	4.70	5.70	3.5
	4.0	4.30	4.20	4.80	4.00	5.10	4.0
	4.5	3.80	3.60	4.30	3.50	4.50	4.5
	5.0	3.30	3.10	3.80	3.00	4.10	5.0
	5.5	2.80	2.70	3.40	2.50	3.60	5.5
	6.0	2.50	2.30	3.00	2.20	3.20	6.0
	6.5	2.10	1.90	2.60	1.80	2.90	6.5
	7.0	1.80	1.60	2.30	1.50	2.60	7.0
	8.0		1.10	1.80	0.95	2.10	8.0
	9.0		0.65	1.40	0.50	1.60	9.0
	10.0			1.00		1.30	10.0
	11.0			0.70		0.95	11.0
	12.0					0.70	12.0
	1	0	50	0	100	0	1
	2	0	0	16	0	33	2
	3	0	0	16	0	33	3
	4	0	0	16	0	33	4
MODE	1,2	1	2	1	2		MODE
[DEG]	0~83.5	31~83.5	5~83.5	51~83.5	29~83.5		[DEG]
	4	4	4	4	4		
						35t	

MB	アウトリガ不使用 走行(1.6km/h以下)					360°	JPN
m	10.3	14.1	14.1	17.8	17.8		m
	3.0	4.30	4.10	5.00			3.0
	3.5	3.40	3.20	4.10	3.00	4.40	3.5
	4.0	2.70	2.40	3.30	2.30	3.70	4.0
	4.5	2.00	1.80	2.70	1.70	3.10	4.5
	5.0	1.50	1.30	2.20	1.20	2.60	5.0
	5.5	1.10	0.90	1.80	0.75	2.10	5.5
	6.0	0.75	0.55	1.40		1.70	6.0
	6.5			1.10		1.40	6.5
	7.0			0.80		1.10	7.0
	8.0					0.70	8.0
	9.0						9.0
	10.0						10.0
	11.0						11.0
	12.0						12.0
	1	0	50	0	100	0	1
	2	0	0	16	0	33	2
	3	0	0	16	0	33	3
	4	0	0	16	0	33	4
MODE	1,2	1	2	1	2		MODE
[DEG]	32~66	54~70	45~70	65~73	53~73		[DEG]
	4	4	4	4	4		
						35t	

■作業半径-揚程図

縮尺1/400

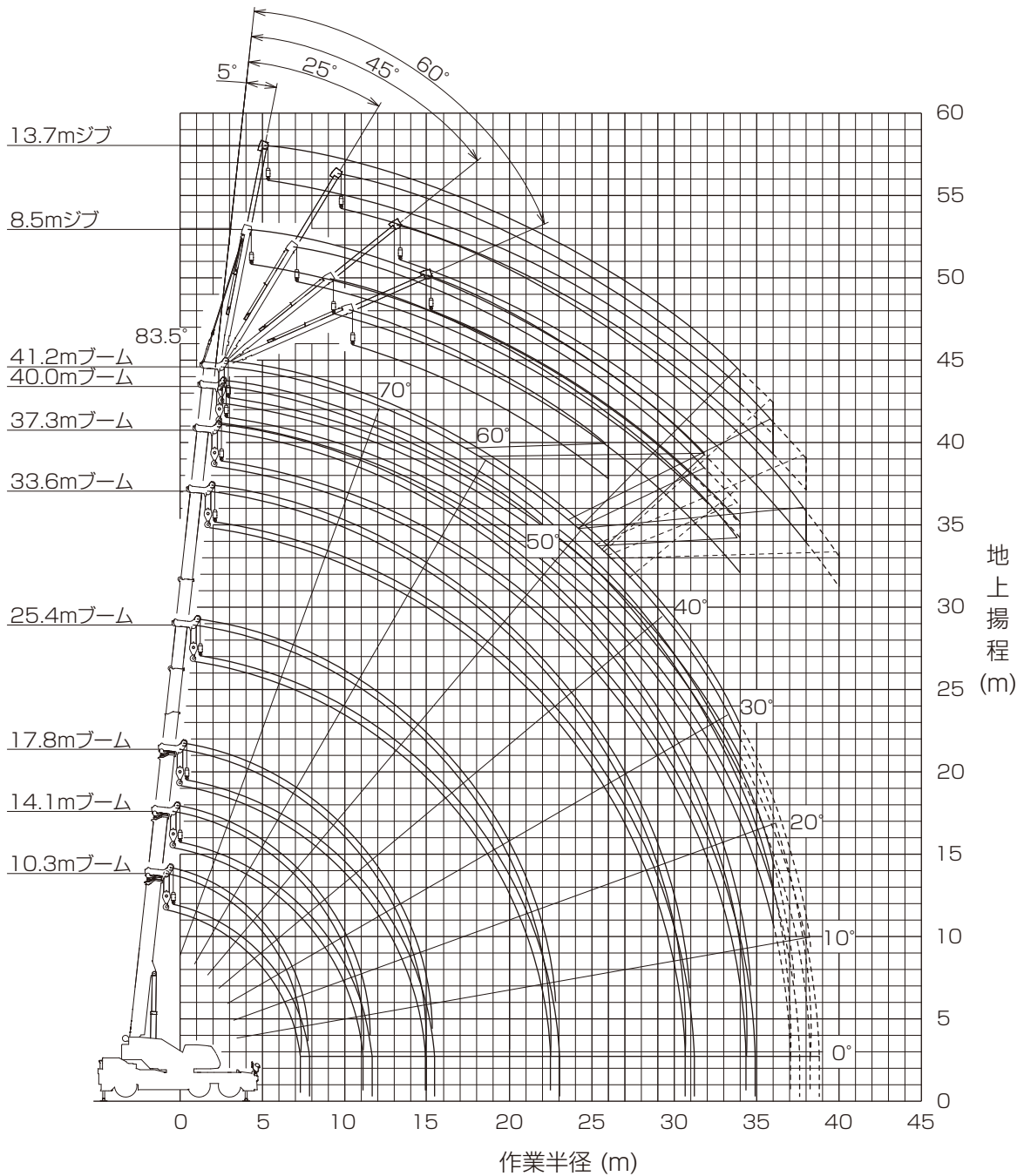

- (注) 1.上図は、ブームおよびジブのたわみを含んでいません。
2.上図は、アウトリガ最大(7.6m)張出状態での図です。
3.上図中、破線の部分は、スマートチャート性能の場合を示します。

■ 作業領域図の見方

【標準性能】

作業領域図の円の大きさは、アウトリガ張出幅で決まる性能に対応しています。

		適用性能 (ブーム作業)	適用性能 (ジブ作業)
円 1	7.6 m	○	○
円 2	7.2 m	○	○
円 3	6.5 m	○	○
円 4	(6.0 m)	○	○
円 5	5.28 m	○	○
円 6	(4.8 m)	○	○
円 7	4.28 m	○	○
円 8	(3.5 m)	○	
円 9	2.36 m	○	

—例—

図のアウトリガ張出幅でブーム作業を行う場合、作業領域別の性能および範囲は、次のようになります。

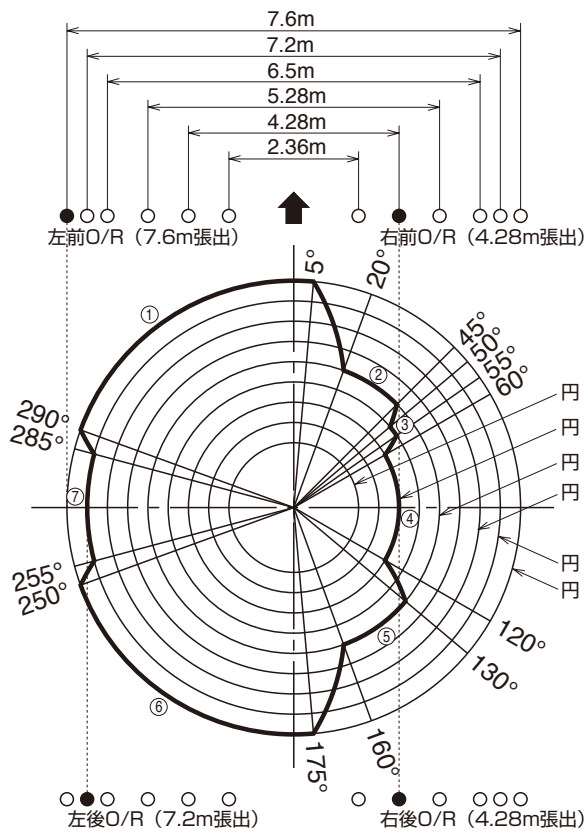

- ①の領域：最大張出（7.6m）性能
- ②の領域：中間張出（5.28m）性能
- ③の領域：アウトリガ張出幅（4.8m）で補間計算した性能
- ④の領域：中間張出（4.28m）性能
- ⑤の領域：中間張出（5.28m）性能
- ⑥の領域：最大張出（7.6m）性能
- ⑦の領域：中間張出（7.2m）性能

それぞれの性能領域を結ぶ切換領域は5°とし、それぞれの性能で比例して増減しています。

【標準性能】

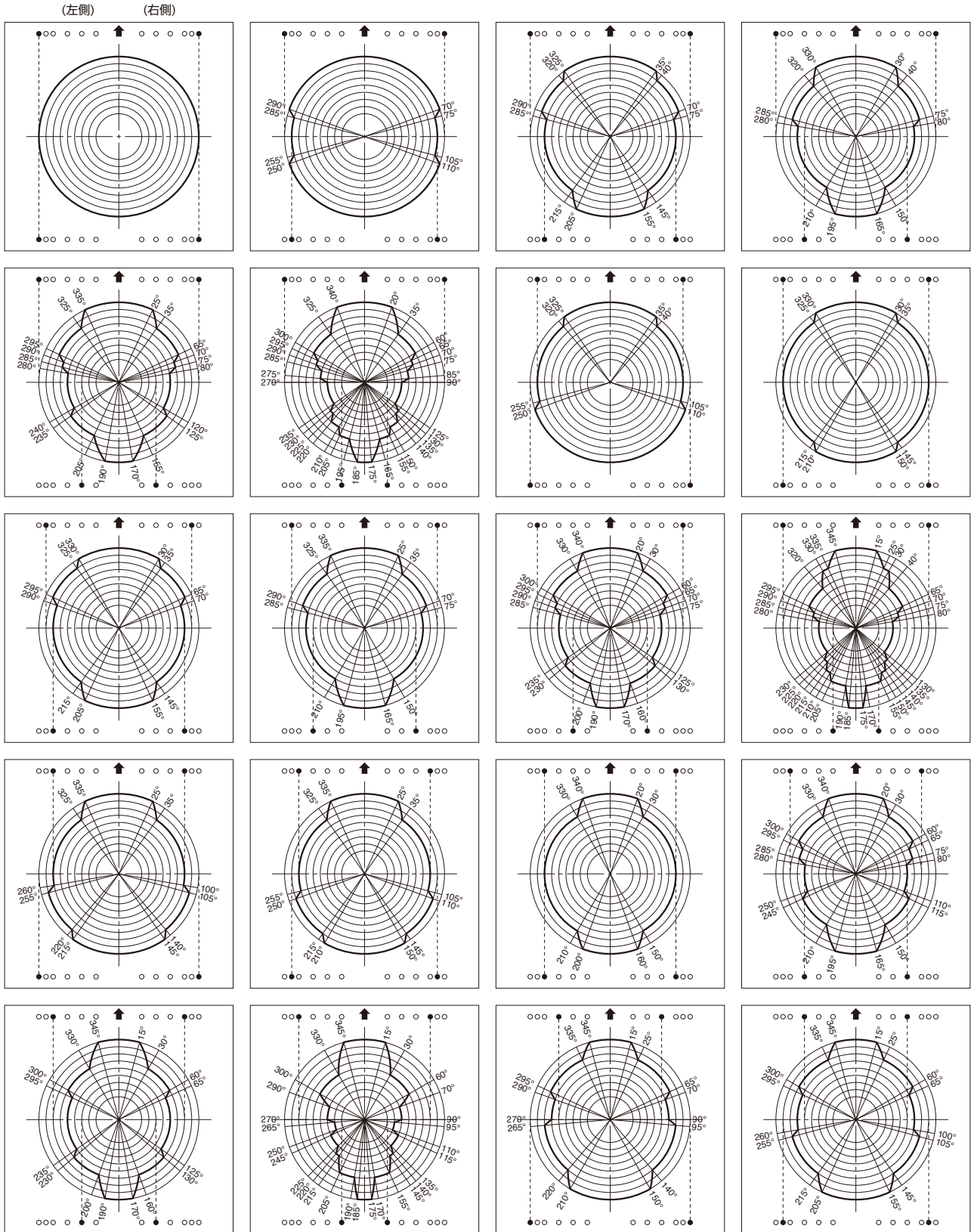

【標準性能】

(左側) (右側)

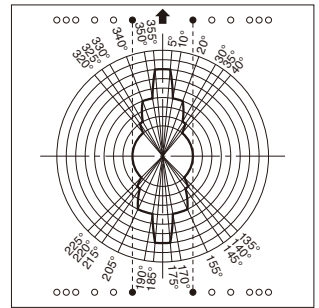
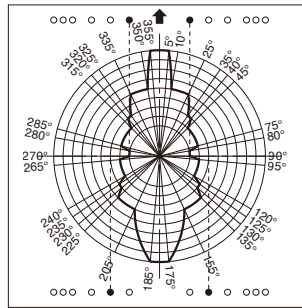
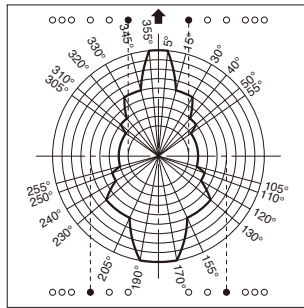
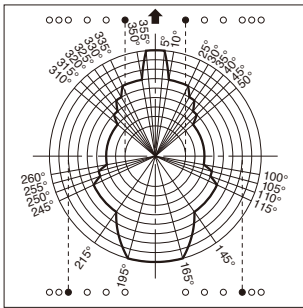
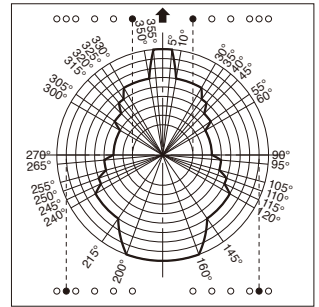
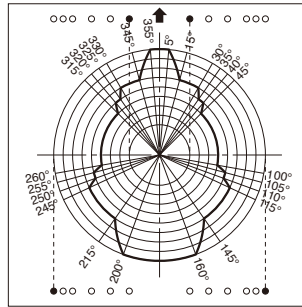
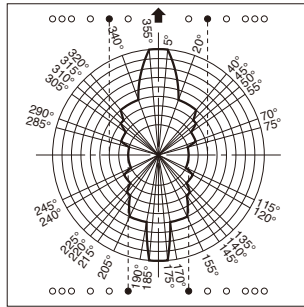
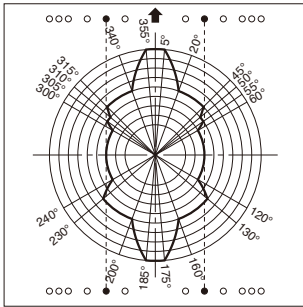
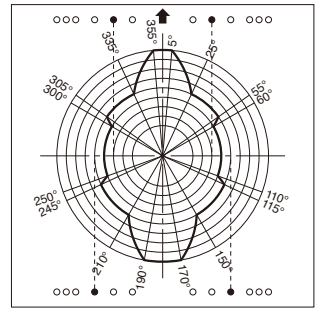
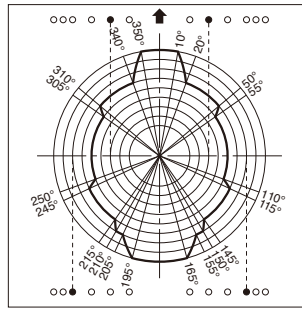
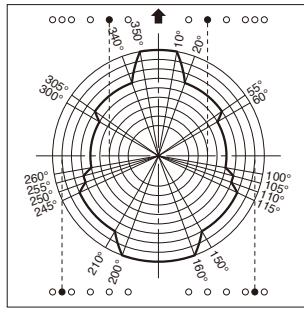
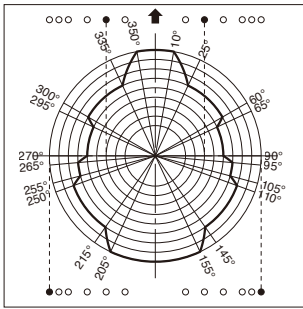
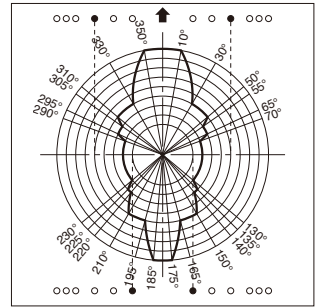
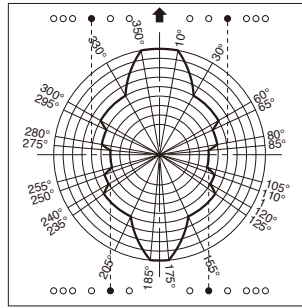
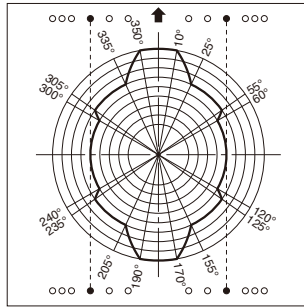
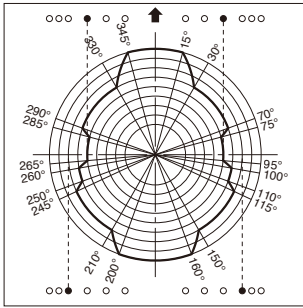

【スマートチャート性能】

作業領域図の円の大きさは、アウトリガ張出幅で決まる性能に対応しています。

領域①	スマートチャート	適用性能 (ブーム作業)	適用性能 (ジブ作業)
円 1	7.6 m	○	○
円 2	7.2 m	○	○
円 3	6.5 m	○	○
円 4	(6.0 m)	○	○
円 5	5.28 m	○	○
円 6	(4.8 m)	○	○
円 7	4.28 m	○	○
円 8	(3.5 m)	○	
円 9	2.36 m	○	

—例—

図のアウトリガ張出幅でブーム作業を行う場合、作業領域別の性能および範囲は、次のようになります。

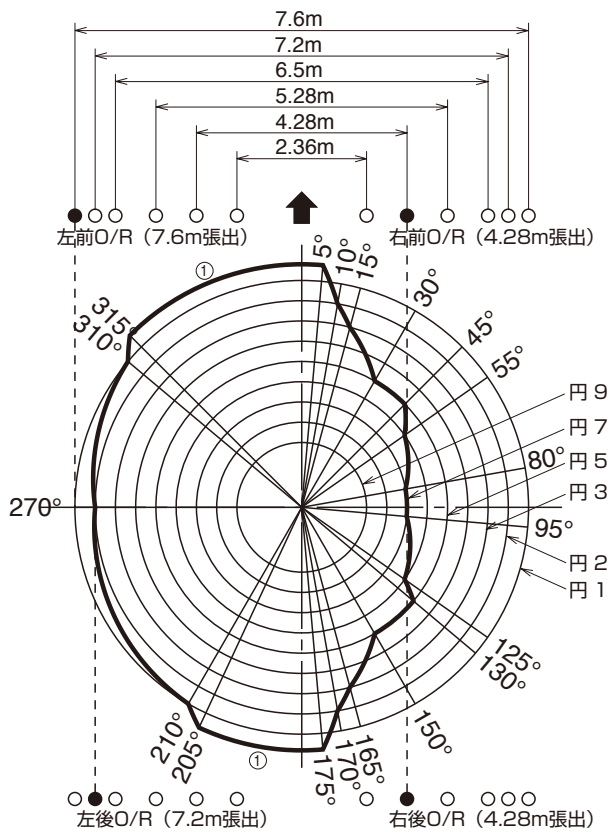

①の領域：スマートチャート性能

それぞれの性能領域を結ぶ切換領域はそれぞれの性能で比例して増減しています。

■ 作業領域図



【スマートチャート性能】

(左側) (右側)

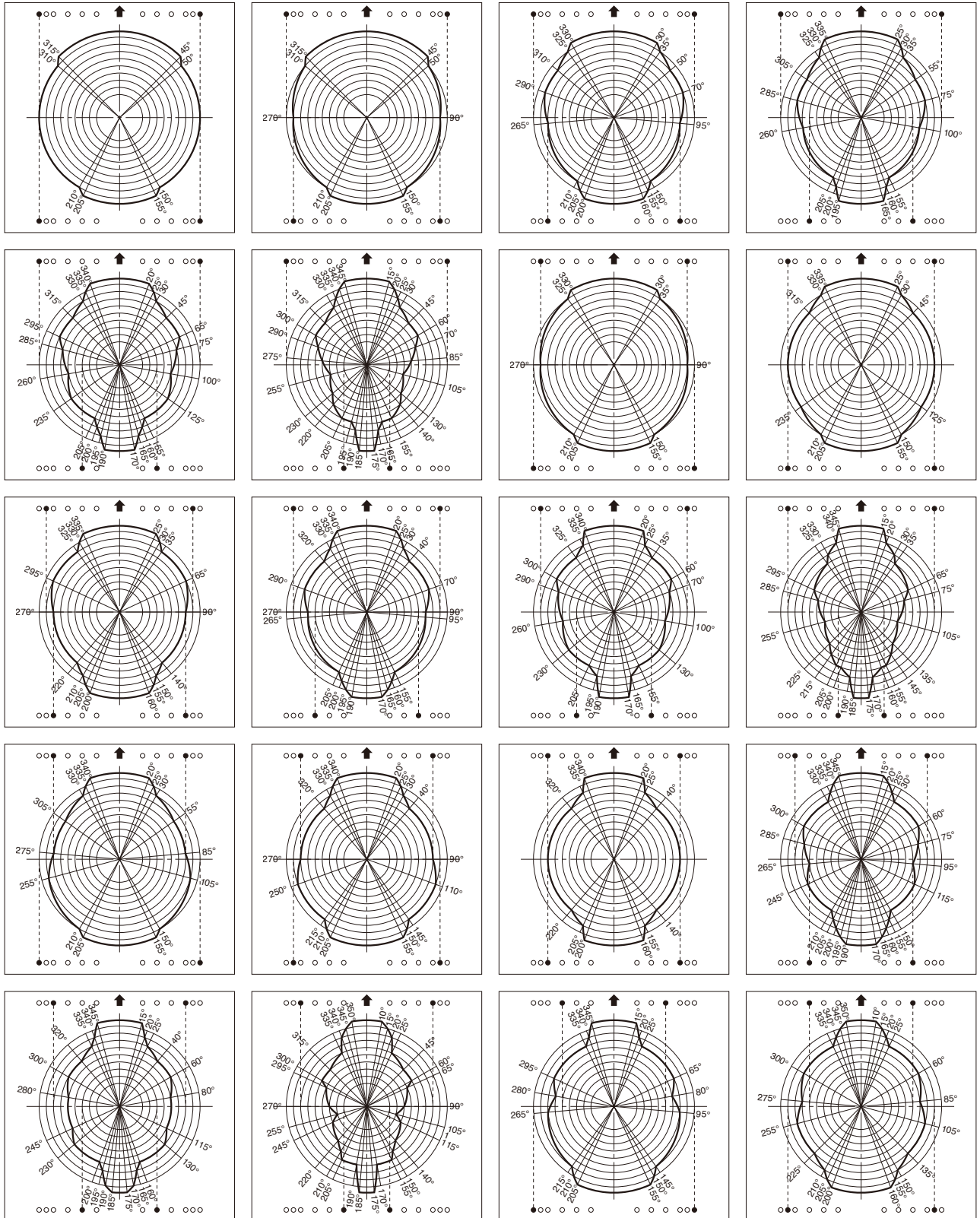

■主要寸法図

ブーム(重荷重装置取付時)

2段フルオートジブ

縮尺1/100
(単位:mm)

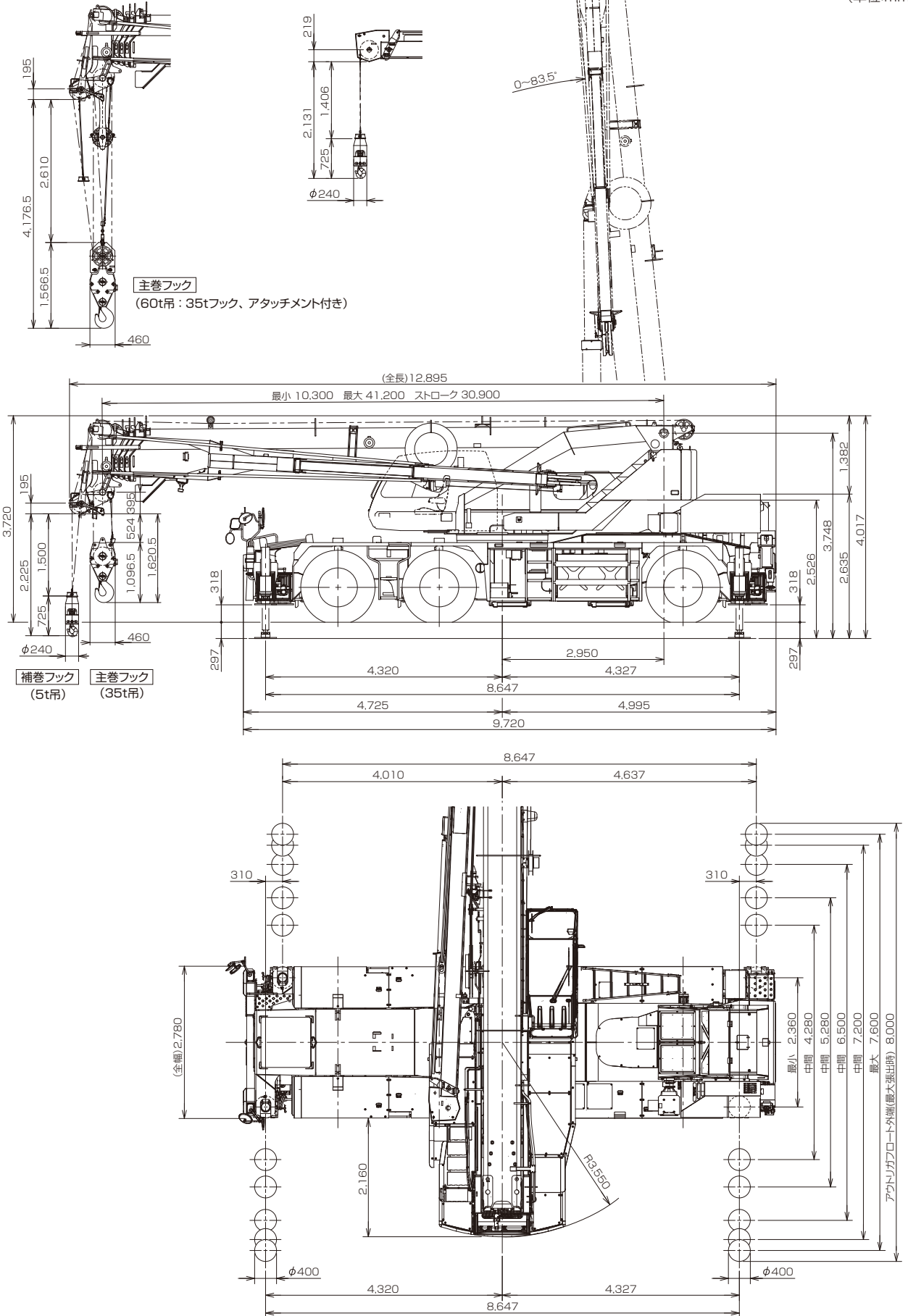

本図に記載のAML外部表示灯、ドラム監視カメラ、作業時リヤカメラ、LEDマーカーランプ、路肩灯、リモコンサーチライトはオプションです。

■外観図

縮尺1/100
(単位:mm)

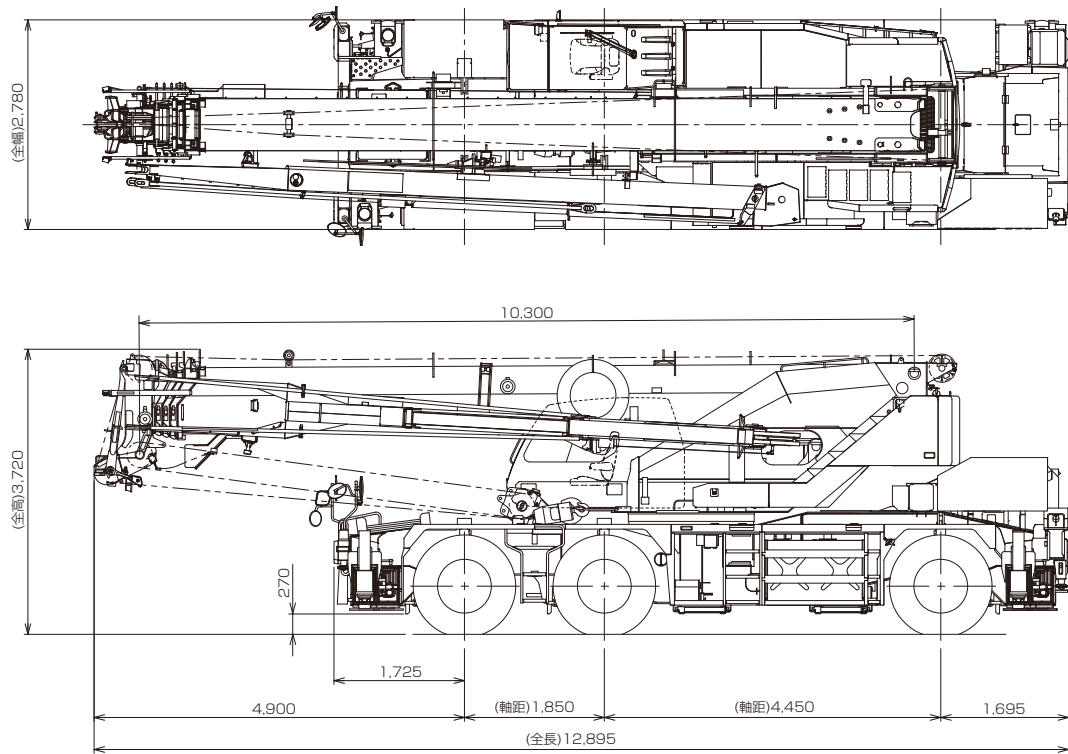

本図に記載の AML外部表示灯、ドラム監視カメラ、後方監視カメラ、マーカーランプ、路肩灯、リモコンサーチライトはオプションです。

- 本機は、新規開発車両証明制度による適合証明書「基本通行条件 重量: D」の交付を受けていますが、実際の通行条件は、経路ごとの道路管理者の算定結果によって付与されます。

■最小直角通路幅

●前4輪ステアリングで右折する場合

- R1=11.00m (最小回転半径)
- R2=11.19m (最外輪端回転半径)
- R3=12.28m (車体回転半径)
- R4=13.85m (ブーム先端回転半径)
- R5=6.25m (車体内側回転半径)
- A=5.85m (入口通路幅)
- B=5.85m (車輪出口通路幅)
- C=6.77m (車体出口通路幅)
- D=8.50m (ブーム先端出口通路幅)

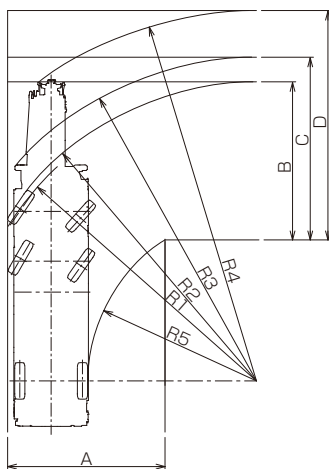

●6輪ステアリングで右折する場合

- R1=6.70m (最小回転半径)
- R2=6.89m (最外輪端回転半径)
- R3=7.14m (車体回転半径)
- R4=9.73m (ブーム先端回転半径)
- R5=2.67m (車体内側回転半径)
- A1=4.08m (車輪入口通路幅)
- A2=5.41m (車体入口通路幅)
- B=4.08m (車輪出口通路幅)
- C=5.41m (車体出口通路幅)
- D=7.43m (ブーム先端出口通路幅)

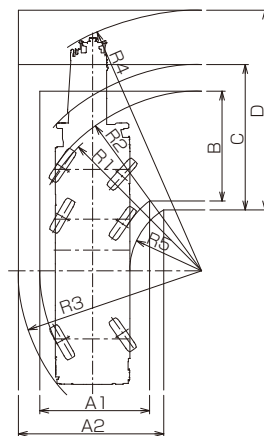

●後2輪ステアリングで右折する場合

- R1=11.13m (最小回転半径)
- R2=11.32m (最外輪端回転半径)
- R3=12.11m (車体回転半径)
- R4=10.77m (ブーム先端回転半径)
- R5=7.16m (車体内側回転半径)
- A1=5.42m (車輪入口通路幅)
- A2=6.20m (車体入口通路幅)
- C=6.20m (車体出口通路幅)
- D=6.75m (ブーム先端出口通路幅)

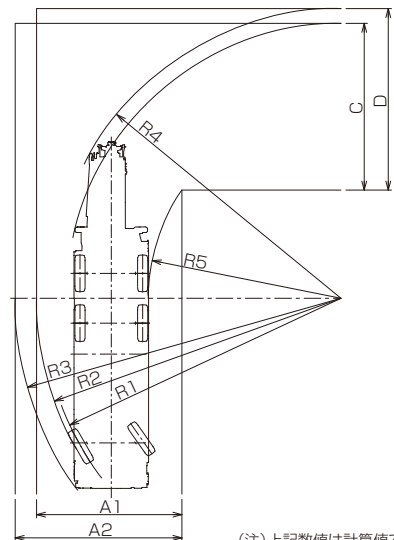

(注)上記数値は計算値です。

型式呼称	仕様	スペック番号
GR-600N	60t吊 5段ブーム 2段フルオートジブ H型アウトリガ	GR-600N-3-00101

※お届けいたします製品は、改良などのため、この仕様書と相違する場合がありますのでご了承ください。

株式会社 タタ